



BLUELINE

2825 W Mercer Way

City of Mercer Island, Washington

Date: March 1st, 2019

Revision Date: August 30th, 2023

Preliminary Storm Drainage Report

Prepared for
OB Mercer Island Properties, LLC
P.O. Box 726
Bellevue, WA 98009

Blueline Job No. 13-118

Prepared by: Lucas Zirotti, EIT
Olivia Westmoreland

Reviewed by: Brett Pudists, PE

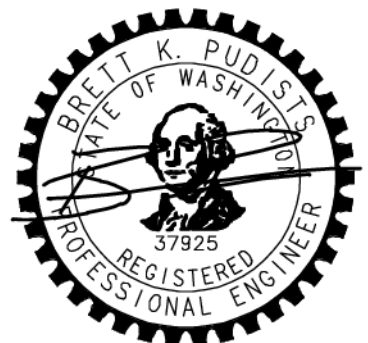

8/30/23

TABLE OF CONTENTS

SECTION 1 PROJECT OVERVIEW1.1

SECTION 2 MINIMUM REQUIREMENTS.....2.1

SECTION 3 OFFSITE ANALYSIS.....3.1

Task 1: Define and Map the Study Area3.1

Task 2: Resource Review.....3.1

Task 3: Field Inspection:.....3.2

Task 4: Drainage System Description.....3.2

Task 5: Downstream Drainage Exhibit.....3.3

Downstream Drainage Photographs – North Basin3.4

Downstream Drainage Photographs – South Basin3.10

SECTION 4 PERMANENT STORMWATER CONTROL PLAN4.1

Existing Conditions.....4.1

Existing Conditions Exhibit.....4.2

Developed Conditions4.3

Developed Conditions Exhibit4.4

Upstream Area.....4.5

4.1 Flow Control Analysis and Design4.6

4.2 Water Quality Analysis and Design4.8

4.3 LID Feasibility Analysis4.10

4.4 Conveyance System Analysis and Design.....4.11

SECTION 5 STORMWATER POLLUTION PREVENTION PLAN5.1

SECTION 6 SPECIAL REPORTS AND STUDIES6.1

SECTION 7 OTHER PERMITS.....7.1

SECTION 8 OPERATIONS AND MAINTENANCE8.1

SECTION 9 BOND QUANTITIES.....9.1



Section 1 Project Overview

The project is located at 2825 W Mercer Way in Mercer Island, WA 98040. More generally, the site is located in NE ¼ of Section 11, Township 24 N, Range 4 E, W.M. Please see the vicinity map below.

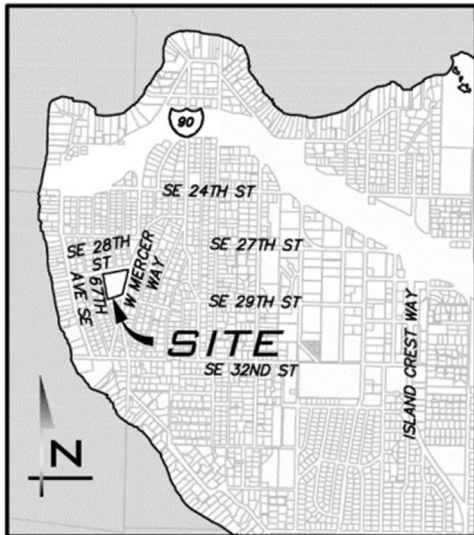

Vicinity Map- Not to Scale

The project site consists of a single 2.88-acre parcel (#217450-2425), and approximately 0.68-acres of frontage improvements along W Mercer Way, SE 28th St, SE 30th St, and 62nd Ave SE. The lot is currently developed with an existing building, parking areas and associated infrastructure. Vegetation is comprised primarily of lawn areas, with mature trees along the property boundaries of the site perimeter. The project proposes the construction of 14 detached single-family homes with associated driveways, utilities, and landscaping. Refer to the *Developed Conditions Exhibit* included in Section 4.

The property is bounded by right-of-way and adjacent single-family residences on all sides.

Per the geotechnical report, the site is generally underlain by very dense silty sand and silt, generally consistent with typical makeup of glacial till. These types of soils are not typically conducive to

infiltration. See Section 6 for the *Geotechnical Engineering Study* prepared by Earth Solutions NW, LLC. dated November 29, 2018.

The site is divided into north and south sub-basins, which drain into Lake Washington within a quarter mile. In the existing condition, runoff along the northern boundary of property generally sheet flows in the westerly direction and is collected in the various catch basins along SE 28th St. The majority of the onsite runoff generally sheet flows in the southwestern direction where it enters drainage ditches along the south and west boundaries of the property and eventually merges with the existing public conveyance system along SE 30th St. Flow control is not required as the project discharges directly to a flow control-exempt receiving water (Lake Washington). The total of pollution-generating hard surface (PGHS) for the project exceeds 5,000 sf and will therefore provide runoff treatment via two StormFilters.

The proposed improvements for this project are greater than 5,000 sf of new impervious area, thus the project, per the Department of Ecology 2012 Stormwater Management Manual for Western Washington, as amended in December 2014 (DOE Manual), and is therefore required to meet Minimum Requirements 1 – 9 as detailed in Section 2.5 of DOE Manual.



Section 2 Minimum Requirements

The following summary describes the minimum stormwater management requirements for the proposed development project per the DOE Manual as adopted by the City of Mercer Island.

MINIMUM REQUIREMENT #1: PREPARATION OF STORMWATER SITE PLANS

All projects meeting the thresholds in section 2.4 shall prepare a stormwater Site Plan for City review. Refer to the Preliminary Plat Submittal included under separate cover for detailed information about the proposed stormwater design.

MINIMUM REQUIREMENT #2: CONSTRUCTION STORMWATER POLLUTION PREVENTION (SWPPP)

See Section 5. A Construction SWPPP will be provided with the final engineering submittal.

MINIMUM REQUIREMENT #3: SOURCE CONTROL OF POLLUTION

All known, available and reasonable source control BMPs must be applied to all projects. Source control BMPs will be selected, designed, and maintained in accordance with the DOE Manual.

MINIMUM REQUIREMENT #4: PRESERVATION OF NATURAL DRAINAGE SYSTEMS AND OUTFALLS

See Sections 3 and 4. Runoff for the proposed development will be routed to leave the site at the existing natural discharge locations and will not cause adverse impacts downstream.

MINIMUM REQUIREMENT #5: ON-SITE STORMWATER MANAGEMENT

See Section 4. Per Section 2.5.5 of the DOE Manual, projects qualifying as flow control exempt in accordance with Section 2.5.7 do not have to achieve the LID performance standard, nor consider bioretention, rain gardens, permeable pavement, and full dispersion if using List #1 or List #2. The remaining BMPs are evaluated as part of this report. All landscaped and open areas will have compost amended soils per BMP T5.13.

MINIMUM REQUIREMENT #6: RUNOFF TREATMENT

See Section 4. The total of PGHS for the project exceeds 5,000 sf, and will therefore provide runoff treatment via two StormFilters.

MINIMUM REQUIREMENT #7: FLOW CONTROL

See Section 4. The project will discharge runoff to a conveyance system that is comprised entirely of manmade conveyance elements directly into Lake Washington (an exempt receiving water) and is therefore exempt from the flow control requirement. During a meeting, neighbor's suggested that groundwater appears during heavy rainfall. This will be addressed in Section 4.4 of the report.



MINIMUM REQUIREMENT #8: WETLANDS PROTECTION

The project will not discharge stormwater into a wetland either directly or indirectly through a conveyance system. Therefore, this Minimum Requirement is not applicable. Refer to the *Critical Area Reconnaissance Memorandum* prepared by The Watershed Company in Section 6.

MINIMUM REQUIREMENT #9 OPERATION AND MAINTENANCE

See Section 8. An operation and maintenance manual will be included with the final engineering submittal.



Section 3 Offsite Analysis

An offsite analysis was conducted on January 3rd, 2019, an overcast day with light rain and temperatures around 50° F.

TASK 1: DEFINE AND MAP THE STUDY AREA

The project is comprised of one parcel (#217450-2425). See Section 4 of this report for the *Existing Conditions Exhibit* and the *Developed Conditions Exhibit*. A Photo Exhibit and Downstream Path Exhibit are provided at the end of this section that show the study area boundaries and the observed stormwater runoff flow path from the site. The project site consists of two drainage basin paths which are further described in Task 3 and 4.

TASK 2: RESOURCE REVIEW

The best available resource information was reviewed for existing or potential problems. The following is a summary of the findings from the information used in preparing this report.

- Per *Geotechnical Engineering Study* prepared by Earthwork Solutions NW, LLC., the soils observed in the test pits consisted of medium dense to very dense silty sand and silt, generally consistent with the typical makeup of glacial till.
- The site is a part of the Mercer Island Drainage Basin (King County iMap). There is one basin with two separate drainage paths that combine within ¼ mile.
- The site does not contain wetlands (King County iMap).
- The site does not contain streams and is not located within a floodplain (King County iMap).
- The site is not located in a Landslide Hazard Area (King County iMap and City of Mercer Island GIS).
- The site is not located in a Seismic Hazard Area (King County iMap and City of Mercer Island GIS).
- The site is not located in an Erosion Hazard Area (King County iMap and City of Mercer Island GIS).
- Refer to the *East Seattle Neighborhood Storm Drainage Basin Study*, on file at the City for commentary on drainage complaints.



TASK 3: FIELD INSPECTION:

A field inspection was conducted for the project at 2825 W Mercer Way on January 3rd, 2019, an overcast day with light rain and temperatures around 50° F. Task 4 of this section contains a detailed description of the downstream drainage paths as well as a *Downstream Path Exhibit*.

Onsite Basin

There is one basin with two separate drainage paths and outfalls to Lake Washington that combine within ¼ mile. Majority of the runoff from the larger subbasin area generally sheet flows southeast across the site and is tributary to drainage ditches along the south and west boundaries of the property. The runoff is then conveyed via public conveyance system along the north side of SE 30th St into the outfall in Lake Washington. A portion of SE 28th St runs along the panhandle portion of the site, providing access to the parking lot located on the west side of the parcel. Runoff from the panhandle portion of the site generally sheet flows to the public conveyances along the south side of SE 28th St and continues westward until the outfall in Lake Washington.

Per the geotechnical report, the site is underlain by very dense silty sand and silt, generally consistent with the typical makeup of glacial till. See Section 6 for Geotechnical Engineering Study prepared by Earth Solutions NW, LLC.

Upstream Area

In the existing condition, surface runoff from a portion of the adjacent streets (W Mercer Way, SE 28th St, and SE 30th St) surrounding the site sheet flows onto the site. These areas will be included in the analysis of the existing conveyance systems. Refer to the *Developed Conditions* provided in Section 4 of this report. In the developed condition, upstream runoff will be intercepted by ditches and catch basins along the project frontages.

TASK 4: DRAINAGE SYSTEM DESCRIPTION

The downstream drainage path was investigated up until the outfall at Lake Washington. Refer to the *Downstream Drainage Exhibit* for the path and photo locations referred to in this section.

Existing Downstream Drainage Path 1 – North Subbasin

Onsite runoff along the edge of the northern parcel boundary sheet flows southwest towards a series of tight-lined catch basins along the south side of SE 28th St (Photos N1-N3). The runoff is then conveyed via the 12" tight-lined system along the south side of SE 28th St toward an outfall in Lake Washington (Photos N4 – N13).

Existing Downstream Drainage Path 2 – South Subbasin

The majority of onsite runoff sheet flows southwest towards a series of open channels and catch basins along the east, west, and southern parcel boundaries (Photo S1-S5). The runoff is conveyed through more open channels, driveway culverts, and catch basins along the north side of SE 30th St until it reaches the outfall in Lake Washington (Photos S5-S13).



DOWNSTREAM DRAINAGE EXHIBIT

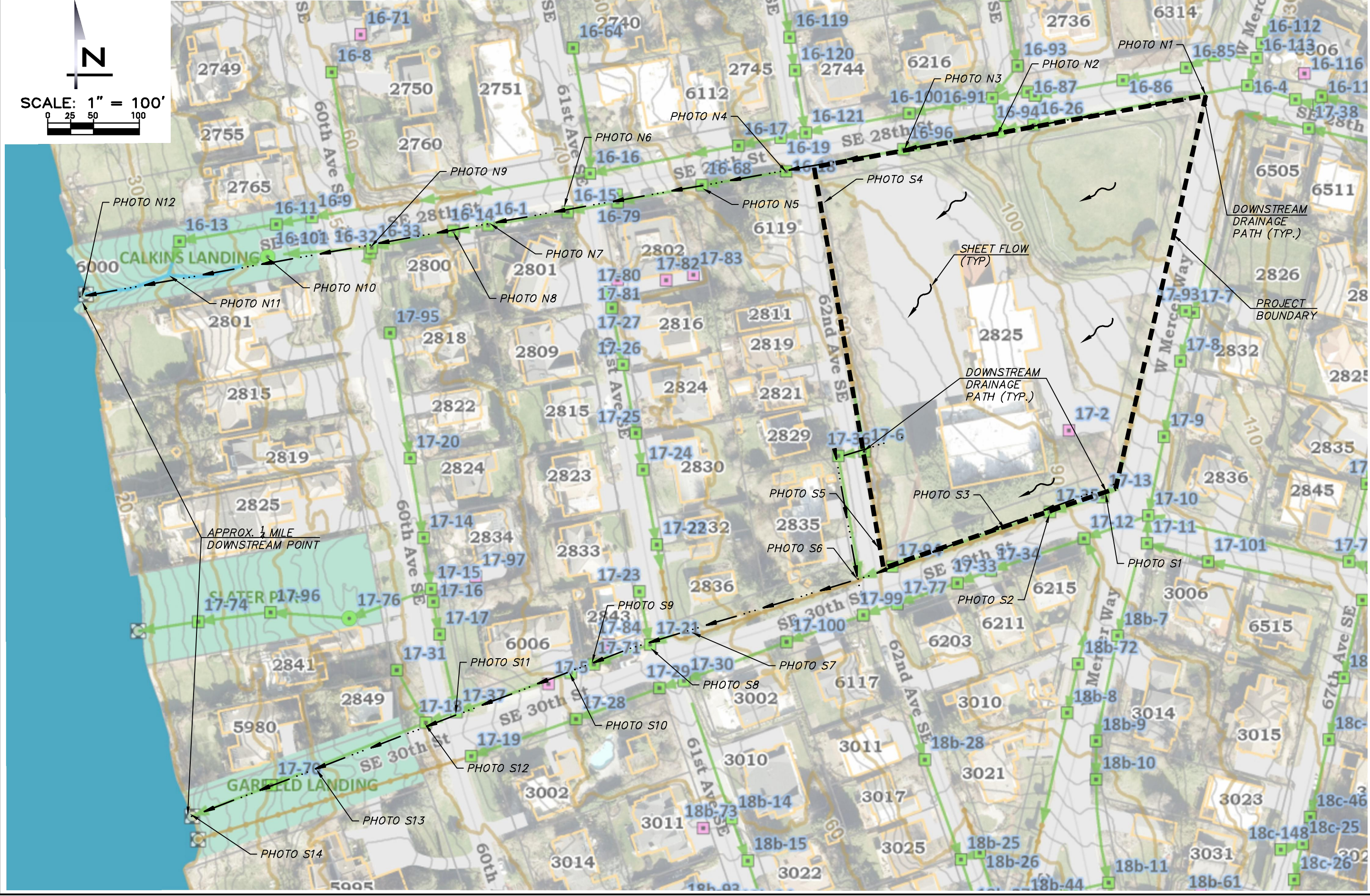
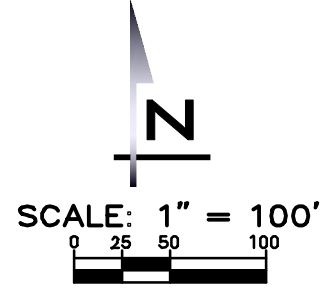

DOWNSTREAM DRAINAGE EXHIBIT
2825 W MERCER WAY
PRELIMINARY STORM DRAINAGE REPORT

SCALE	AS NOTED
PROJECT MANAGER	BRETT PUDISTS, PE
DESIGNED BY	AARON LANCE
DRAWN BY	OLIVIA WESTMORELAND
PLOT DATE	June 19, 2023
JOB NUMBER:	
13-118	
FIGURE:	
DS	

Jun 19, 2023 - 10:40am - User owestmoreland
 E:\Projects\13118\DWG\Exhibits\Drainage\13118_DS.dwg

DOWNSTREAM DRAINAGE PHOTOGRAPHS – NORTH BASIN

Note: See the Downstream Drainage Exhibit for numbered locations of pictures.



Photo N1 – Facing west along SE 28th St. Onsite runoff sheet flows northwest toward the conveyance system on the south side of the street.

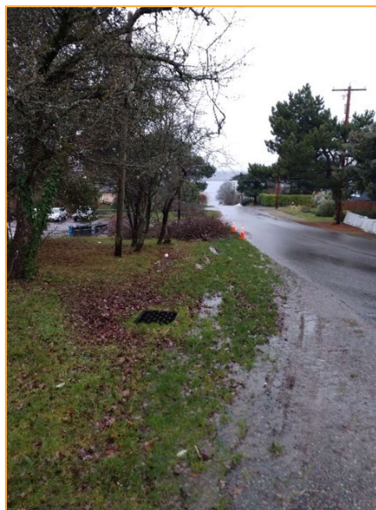

Photo N2 – Facing west along SE 28th St approximately 170 feet west of Photo N1. Runoff continues to sheet flow northwest towards the conveyance system on the south side of the street.





Photo N3 – Facing west along SE 28th St approximately 145 feet west of Photo N2. This catch basin is located adjacent to the driveway into the back parking lot on the western portion of the property. Runoff continues to sheet flow northwest towards the conveyance system on the south side of the street.



Photo N4 – Facing west along SE 28th St approximately 130 feet west of Photo N3. Runoff is conveyed via this catch basin on the south side of the street toward Lake Washington.





Photo N5 – Facing west along SE 28th St approximately 95 feet west of Photo N4. Runoff is conveyed via this catch basin on the south side of the street toward Lake Washington.



Photo N6 – Facing west along SE 28th St approximately 150 feet west of Photo N5. Runoff is conveyed via this catch basin on the south side of the street toward Lake Washington.





Photo N7 – Facing west along SE 28th St approximately 90 feet west of Photo N6. Runoff is conveyed via this catch basin on the south side of the street toward Lake Washington.



Photo N8 – Facing west along SE 28th St approximately 40 feet west of Photo N7. Runoff is conveyed via this catch basin on the south side of the street toward Lake Washington.





Photo N9 – Facing west along SE 28th St approximately 95 feet west of Photo N8 at southeast corner of the intersection of SE 28th St and 60th Ave SE. Runoff is conveyed via this catch basin on the south side of the street toward Lake Washington.



Photo N10 – Facing west in Calkins Landing approximately 95 feet west of Photo N9. Runoff is collected in the pre-settling vault pictured before being discharged into Lake Washington.





Photo N11 – Facing west in Calkins Landing. Runoff discharges via a pipe with a trash rack to a ditch upstream of the outfall to Lake Washington.



Photo N12 – Facing west in Calkins Landing showing the outfall in Lake Washington.



DOWNSTREAM DRAINAGE PHOTOGRAPHS – SOUTH BASIN

Note: See the Downstream Drainage Exhibit for numbered locations of pictures.



Photo S1 – Facing west along the north side of SE 30th St. Onsite runoff sheet flows in the southwestern direction to the catch basin above and is conveyed west toward Lake Washington.



Photo S2 – Facing west along the north side of SE 30th St approximately 55 feet west of Photo S1. Onsite runoff sheet flows in the southwestern direction to the catch basin above and is conveyed west toward Lake Washington.





Photo S3 – Facing west along the north side of SE 30th St approximately 35 feet west of Photo S2. Onsite runoff sheet flows in the southwestern direction to the ditch above and is conveyed west toward Lake Washington.



Photo S4 – Facing south on the east side of 62nd Ave SE approximately 60 feet from Photo N4. Onsite runoff sheet flows in the southwest direction toward the ditch above and is conveyed south to be combined with the south basin downstream conveyance system.





Photo S5 – Facing north on the east side of 62nd Ave SE approximately 365 feet from Photo S4. Onsite runoff sheet flows in the southwest direction toward the ditch above and is conveyed south to be combined with the south basin downstream conveyance system.



Photo S6 – Facing west along the north side of SE 30th St approximately 40 feet west of Photo S5 at the northwest corner of the intersection of SE 30th St and 62nd Ave SE. Runoff is conveyed west from this pipe outfall toward Lake Washington.





Photo S7 – Facing east along the north side of SE 30th St approximately 210 feet west of Photo S6 at the northeast corner of the intersection of SE 30th St and 61st Ave SE. Runoff is conveyed west toward Lake Washington.



Photo S8 – Facing west along the north side of SE 30th St approximately 30 feet west of Photo S7 at the northwest corner of the intersection of SE 30th St and 61st Ave SE. Runoff is conveyed west toward Lake Washington.





Photo S9 – Facing west along the north side of SE 30th St approximately 65 feet west of Photo S8. Runoff is conveyed west toward Lake Washington.



Photo S10 – Facing west along the north side of SE 30th St approximately 30 feet west of Photo S9. Runoff is conveyed west toward Lake Washington.





Photo S11 – Facing west along the north side of SE 30th St approximately 130 feet west of Photo S10 at the northeast corner of the intersection of SE 30th St and 60th Ave SE. Runoff is conveyed west toward Lake Washington.



Photo S12 – Facing west in front of the entrance to Garfield Landing approximately 35 feet west of Photo S11. Runoff is conveyed west toward Lake Washington.





Photo S13 – Facing west in Garfield Landing. Runoff is conveyed west to the outfall into Lake Washington.



Photo S14 – Facing east looking directly at the outfall to Lake Washington.



Section 4 Permanent Stormwater Control Plan

The permanent stormwater control plan includes water quality treatment facilities and storm conveyance system designed and sized according to the DOE Manual. The site is exempt from providing a flow control facility per Section 2.5.7 of the DOE Manual.

EXISTING CONDITIONS

The project site consists of a single 2.88-acre parcel (#217450-2425), and approximately 0.68-acres of frontage improvements along W Mercer Way, SE 28th St, SE 30th St, and 62nd Ave SE. The lot is currently developed with an existing building, parking areas and associated infrastructure. Vegetation is comprised primarily of lawn areas, with mature trees along the property boundaries of the site perimeter. Refer to the *Existing Conditions Exhibit* included on the following page. See below for existing conditions land cover.

EXISTING CONDITIONS

Pervious

Parcel	1.43	ac
Frontage	0.68	ac
Total Pervious (Soil Group C – Till)	2.11	ac

Impervious

Parcel	1.45	ac
Total Impervious	1.45	ac

TOTAL EXISTING CONDITIONS	3.56	ac
----------------------------------	-------------	-----------



EXISTING CONDITIONS EXHIBIT

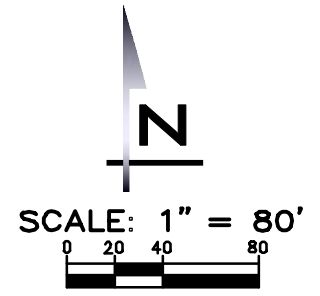

EXISTING CONDITIONS EXHIBIT
2825 W MERCER WAY
PRELIMINARY STORM DRAINAGE REPORT
 © 2023 THE BLUELINE GROUP

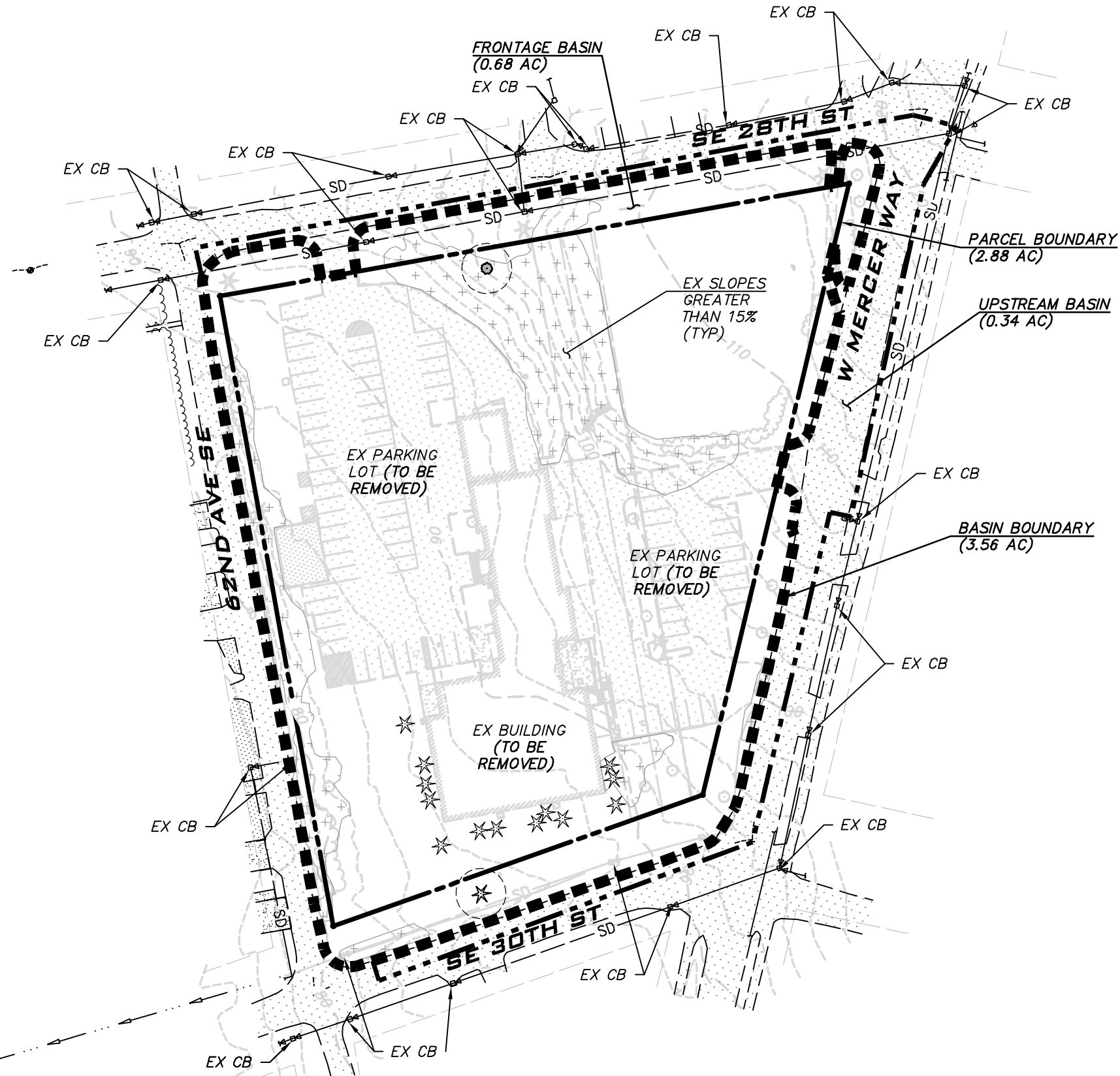

Jun 19, 2023 - 10:40am - User owestmoreland
 E:\Projects\13118\DWG\Exhibits\Drainage\13118_EC.dwg

SCALE	AS NOTED
PROJECT MANAGER	BRETT PUDISTS, PE
DESIGNED BY	AARON LANCE
DRAWN BY	OLIVIA WESTMORELAND
PLOT DATE	June 19, 2023
JOB NUMBER: 13-118	
FIGURE: EC	

DEVELOPED CONDITIONS

The project site consists of a single 2.88-acre parcel (#217450-2425), and approximately 0.68-acres of frontage improvements along W Mercer Way, SE 28th St, SE 30th St, and 62nd Ave SE. The proposed development includes the construction of 14 single-family homes and associated driveways, and utilities. The site is split into a north and south subbasin, based on the proposed grading and stormwater conveyance systems. The site is exempt from providing a flow control facility. Treatment of runoff for basic water quality is proposed through two StormFilters. Refer to the *Developed Conditions Exhibit* included on the following page. See below for existing conditions land cover.

DEVELOPED CONDITIONS

Pervious

Lot	1.47	ac
Frontage	0.35	ac
Total Impervious	1.82	ac

Impervious

Lot	1.41	ac
Frontage	0.33	ac
Total Pervious (Till - Soil Group C)	1.74	ac

TOTAL DEVELOPED CONDITIONS	3.56	ac
-----------------------------------	-------------	-----------



DEVELOPED CONDITION EXHIBIT



BLUELINE

25 CENTRAL WAY, SUITE 400
KIRKLAND, WA 98033
P: 425.216.4000 F: 425.216.4002
WWW.THEBLUELINEGROUP.COM

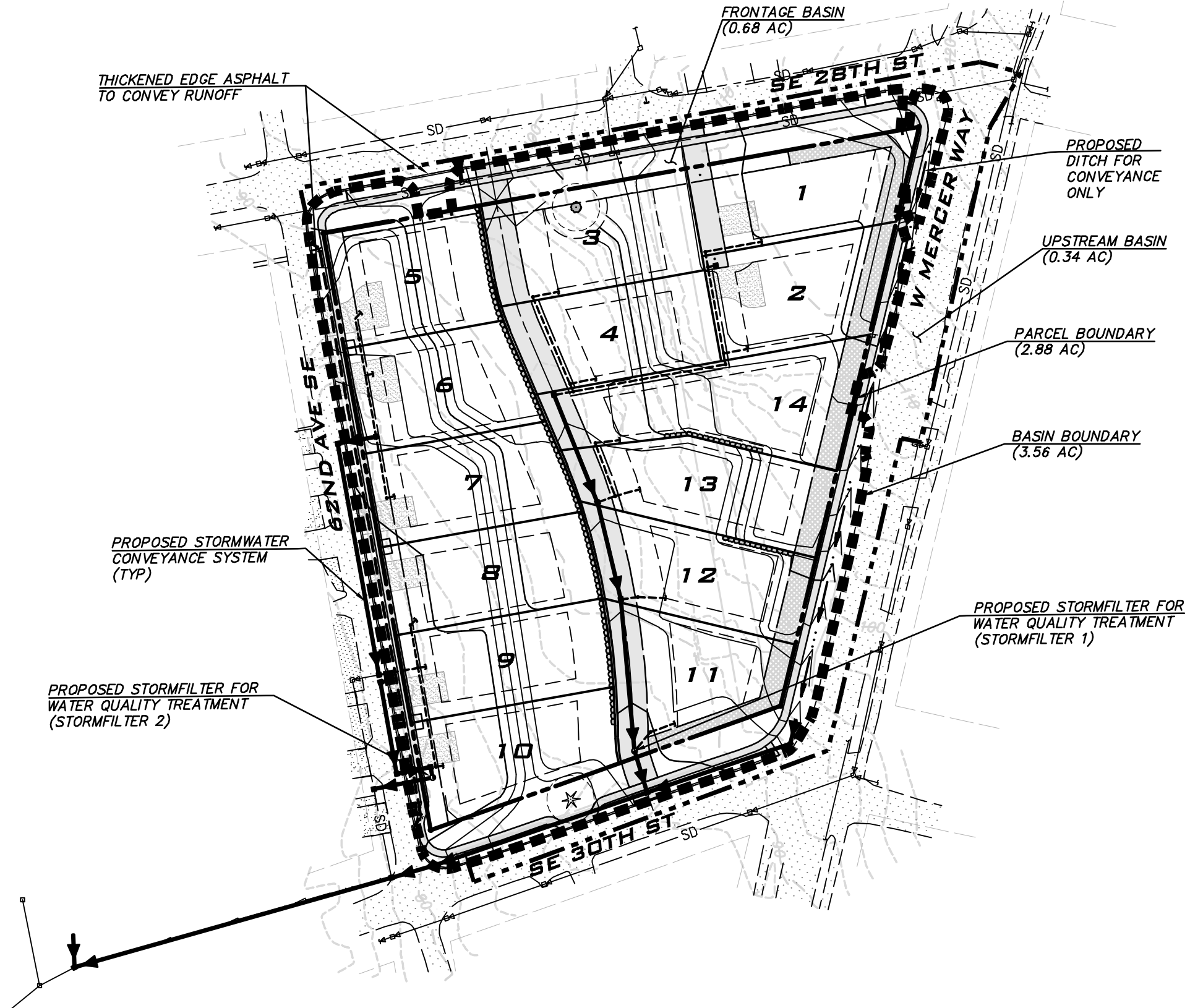
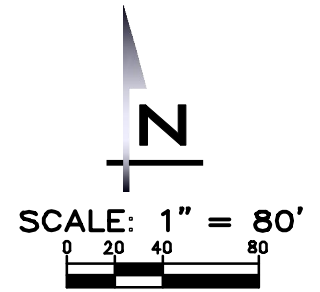

DEVELOPED CONDITION EXHIBIT
2825 W MERCER WAY
PRELIMINARY STORM DRAINAGE REPORT

© 2023 THE BLUELINE GROUP

SCALE	AS NOTED
PROJECT MANAGER	BRETT PUDISTS, PE
DESIGNED BY	AARON LANCE
DRAWN BY	OLIVIA WESTMORELAND
PLOT DATE	August 30, 2023

JOB NUMBER:
13-118

FIGURE:
DC

UPSTREAM AREA

In the existing condition, surface runoff from a portion of the adjacent streets (W Mercer Way, SE 28th St, and SE 30th St) surrounding the site sheet flows onto the site. These areas will be included in the analysis of the existing conveyance systems. Refer to the *Developed Conditions* provided on the following pages. In the developed condition, upstream runoff will be intercepted by ditches and catch basins along the project frontages.

TOTAL UPSTREAM AREAImpervious

Upstream Area (Existing Roadway)	0.34	ac
Total Impervious	0.34	ac
TOTAL UPSTREAM AREA	0.34	ac



4.1 FLOW CONTROL ANALYSIS AND DESIGN

Per Section 2.5.7, Volume I of the DOE Manual, Flow Control is not required for projects that discharge directly to, or indirectly to Lake Washington subject to the following restrictions:

- Direct discharge to the exempt receiving water does not result in the diversion of drainage from any perennial stream classified as Types 1, 2, 3, or 4 in the State of Washington Interim Water Typing System, or Types “S”, “F”, or “Np” in the Permanent Water Typing System, or from any category I, II, or III wetland
The project is not proposing to divert drainage from any perennial stream classified as Types 1, 2, 3, or 4 in the State of Washington Interim Water Typing System, or Types “S”, “F”, or “Np” in the Permanent Water Typing System, or from any category I, II, or III wetland.
- Flow splitting devices or drainage BMP’s are applied to route natural runoff volumes from the project site to any downstream Type 5 stream or category IV wetland:
The project is not proposing to discharge to a downstream Type 5 stream or category IV wetland.
 - Design of flow splitting devices or drainage BMP’s will be based on continuous hydrologic modeling analysis. The design will assure that flows delivered to Type 5 stream reaches will approximate, but in no case exceed, durations ranging from 50% of the 2-year to the 50-year peak flow.
Not applicable
 - Flow splitting devices or drainage BMP’s that deliver flow to category IV wetlands will also be designed using continuous hydrologic modeling to preserve pre-project wetland hydrologic conditions unless specifically waived or exempted by regulatory agencies with permitting jurisdiction
Not applicable
- The project site must be drained by a conveyance system that is comprised entirely of manmade conveyance elements (e.g., pipes, ditches, outfall protection) and extends to the ordinary high water line of the exempt receiving water
The project site drains to a conveyance system that is comprised entirely of manmade conveyance elements and extends to the ordinary high water line of the exempt receiving water.
- The conveyance system between the project site and the exempt receiving water shall have sufficient hydraulic capacity to convey discharges from future build-out conditions (under current zoning) of the site, and the existing condition from non-project areas from which runoff is or will be collected
Improvements to the existing conveyance system are proposed in order to provide sufficient hydraulic capacity to convey discharges from future build-out conditions (under current zoning) of the site and the existing condition from non-project areas from which runoff is or will be collected. Refer to discussion below regarding the proposed improvements.



- Any erodible elements of the manmade conveyance system must be adequately stabilized to prevent erosion under the conditions noted above.
Existing ditches will be evaluated for stability as part of this project. The existing ditch on the north side of SE 30th St between 62nd Ave SE and 61st Ave SE will be tightlined per recommendations from the City's stormwater operations team.

The City prepared the *East Seattle Neighborhood Storm Drainage Basin Study* to assess the capacity of the existing storm conveyance system. Refer to the study on file at the City. The downstream paths associated with this project were evaluated as part of the study.

The area and land cover tributary to the north downstream path are proposed to mimic the existing condition. As such, no improvements to the north downstream path are proposed.

The onsite impervious area tributary to the south downstream path (1.41 acres) is less than the existing onsite impervious area (1.49 acres). The total proposed impervious surface, including 0.33 acres of frontage impervious, is 1.74 acres, which results in a 0.25-acre increase in impervious surfaces. The conversion of approximately 0.25 acres of pervious to impervious area results in a 0.12 cfs increase as evaluated using the Western Washington Hydrology Model.

Per the *East Seattle Neighborhood Storm Drainage Basin Study*, the existing 12-inch pipe across 60th Ave SE on the north side of SE 30th St needs to be replaced. This can be accomplished without any changes to the pipes immediately downstream and upstream of this segment, provided the revised pipe grade would not be in conflict with any existing utilities. The second iteration upstream IE from the backwater spreadsheet is reflected in the preliminary plans.

The existing ditch on the north side of SE 30th St between 62nd Ave SE and 61st Ave SE will be tightlined per recommendations from the City's stormwater operations team. The proposed 12-inch pipe will need to convey 5.11 cfs per the *East Seattle Neighborhood Storm Drainage Basin Study* plus the 0.12 cfs increase associated with this project, 5.23 cfs. The capacity for the 12-inch pipe was calculated using Manning's Equation. Per Manning's equation, a 12-inch pipe at 4.16% has capacity to convey 8.59 cfs. Therefore, the 12-inch pipe has adequate capacity to convey the 100-year storm. Please see calculations for the conveyance system on the following page.

MANNING'S EQUATION; 12" PIPE @ 4.16% = 8.59 CFS

$$Q = 1.486/n * A * R^{2/3} * S^{1/2}$$

$$n = \text{roughness coefficient} = \mathbf{0.011}$$

$$A = \text{cross sectional area of pipe} = \pi (D/2)^2 = \pi (1/2)^2 = \mathbf{0.785}$$

$$R = \text{wetted perimeter of pipe}$$

$$R^{2/3} = (D/4)^{2/3} = (1/4)^{2/3} = \mathbf{0.397}$$

$$S = \text{slope}$$

$$S^{1/2} = (0.0416 \text{ ft/ft})^{1/2} = \mathbf{0.204}$$

$$Q = (1.486/0.011) * 0.785 * 0.397 * 0.204 = \mathbf{8.59 \text{ cfs}}$$



4.2 WATER QUALITY ANALYSIS AND DESIGN

The total PGHS for the project exceeds 5,000 SF, and therefore, will provide runoff treatment two StormFilters.

STORMFILTER 1

A Contech StormFilter (Stormfilter 1) is proposed to be located within the private driveway and is intended to treat PGHS from the private driveway and driveways on Lots 1-2. The StormFilter will be sized based on the total area tributary to it and includes NPGHS (roof and lawn). The StormFilter using ZPG Media has GULD approval from DOE for basic treatment. Per the approval, the water quality flow rate is the peak 15-minute flow rate as calculated using the latest version of the Western Washington Hydrology Model (WWMH) or other Ecology-approved continuous runoff model. The water quality flow rate is 0.1426 cfs. The StormFilter size and configuration will be assessed at final engineering. See below for tributary areas and WWHM flows.

STORMFILTER 1 TRIBUTARY

Impervious

Lots	0.84	ac
ROW	0.01	ac
Total Impervious	0.85	ac

Pervious

Lots	0.88	ac
ROW	0.09	ac
Total Pervious (Till - Soil Group C)	0.97	ac

TOTAL STORMFILTER 1 TRIBUTARY	1.82	ac
--------------------------------------	-------------	-----------

The screenshot displays a software interface for stormwater analysis. On the left is a button labeled 'Run Analysis'. To its right are two panels. The 'On-Line BMP' panel contains two input fields: '24 hour Volume (ac-ft)' with a value of 0.1356 and 'Standard Flow Rate (cfs)' with a value of 0.1426. The 'Off-Line BMP' panel contains one input field: 'Standard Flow Rate (cfs)' with a value of 0.0789.



STORMFILTER 2

A second Contech Stormfilter (Stormfilter 2) is intended to treat PGHS from the driveways of Lots 5-10. The Stormfilter will be located at the southwest corner of Lot 10 and will be privately maintained. Stormfilter 2 will also pick up an additional 0.09 acres of PGHS associated with 62nd Ave SE that is non-targeted existing PGHS and not currently treated.

The StormFilter will be sized based on the total area tributary to it. The StormFilter using ZPG Media has GULD approval from DOE for basic treatment. Per the approval, the water quality flow rate is the peak 15-minute flow rate as calculated using the latest version of the Western Washington Hydrology Model (WWMH) or other Ecology-approved continuous runoff model. The water quality flow rate is 0.0489 cfs. The StormFilter size and configuration will be assessed at final engineering. See below for tributary areas and WWHM flows.

STORMFILTER 2 TRIBUTARY

Impervious

Driveways	0.09	ac
ROW	0.18	ac
Total Impervious	0.27	ac
<hr/>		
TOTAL STORMFILTER 2 TRIBUTARY	0.27	ac

The screenshot shows a software interface for stormwater analysis. On the left is a button labeled "Run Analysis". To its right are two panels. The "On-Line BMP" panel contains two input fields: "24 hour Volume (ac-ft)" with a value of 0.0326 and "Standard Flow Rate (cfs)" with a value of 0.0489. The "Off-Line BMP" panel contains one input field: "Standard Flow Rate (cfs)" with a value of 0.0276.



4.3 LID FEASIBILITY ANALYSIS

Projects qualifying as flow control exempt in accordance with Section 2.5.7, Volume I of the DOE Manual do not have to achieve the LID performance standard, nor consider bioretention, rain gardens, permeable pavement, and full dispersion if using List #1 or List #2. However, those projects must implement BMP T5.13; BMPs T5.10A, B, or C; and BMP T5.11 or T5.12, if feasible. See below for feasibility evaluation of these BMPs.

BMP T5.13 Post-Construction Soil Quality and Depth

BMP T5.13 will be applied to landscaped areas on the project site.

BMP T5.10A Downspout Full Infiltration

Per *Figure 3. Low impact development infiltration feasibility on Mercer Island.*, the project site falls within an area where infiltrating LID facilities are not permitted. As such, this BMP will not be implemented.

BMP T5.10B Downspout Dispersion Systems

BMP T5.10B will not be implemented as the available flow path does not meet BMP design criteria.

BMP T5.10C Perforated Stub-out Connections

Per *Figure 3. Low impact development infiltration feasibility on Mercer Island.*, the project site falls within an area where infiltrating LID facilities are not permitted. As such, this BMP will not be implemented.

BMP T5.11 Concentrated Flow Dispersion

BMP T5.10B will not be implemented as the available flow path does not meet BMP design criteria.

BMP T5.12 Sheet Flow Dispersion

BMP T5.10B will not be implemented as the available flow path does not meet BMP design criteria.



4.4 CONVEYANCE SYSTEM ANALYSIS AND DESIGN

Per public concerns, ponding is seen during heavy rainfall which may indicate the presence of groundwater. If groundwater appears during construction, underdrains will be placed in accordance with geotechnical recommendations. The groundwater will be collected by underdrains and an interceptor trench that will be connected to the public conveyance system. The conveyance system will be designed in accordance with the DOE Manual. Conveyance system analysis and design will be provided at final engineering.



Section 5 Stormwater Pollution Prevention Plan

Design of the SWPPP will be completed in accordance with the DOE Manual. The SWPPP will be provided with the final engineering submittal.



Section 6 Special Reports and Studies

Additional reports and studies within this section include the following:

- Geotechnical Engineering Study, dated November 29, 2018, prepared by Earth Solutions NW, LLC.
- Critical Area Reconnaissance Memorandum, dated January 18, 2019, prepared by The Watershed Company.

These reports are included on the following pages.





Geotechnical Engineering
Construction Observation/Testing
Environmental Services



**GEOTECHNICAL ENGINEERING STUDY
PROPOSED RESIDENTIAL DEVELOPMENT
3000 WEST MERCER WAY
MERCER ISLAND, WASHINGTON**

ES-2964.01

1805 - 136th Place N.E., Suite 201 - Bellevue, WA 98005
(425) 449-4704 Fax (425) 449-4711
www.earthsolutionsnw.com

PREPARED FOR
OB MERCER ISLAND PROPERTIES, LLC

November 29, 2018



Adam Z. Shier, G.I.T.
Staff Geologist



Raymond A. Coglas, P.E.
Principal Engineer

GEOTECHNICAL ENGINEERING STUDY
PROPOSED RESIDENTIAL DEVELOPMENT
3000 WEST MERCER WAY
MERCER ISLAND, WASHINGTON

ES-2964.01

Earth Solutions NW, LLC
1805 – 136th Place Northeast, Suite 201
Bellevue, Washington 98005
Phone: 425-449-4704 | Fax: 425-449-4711
www.earthsolutionsnw.com

Important Information About Your Geotechnical Engineering Report

Subsurface problems are a principal cause of construction delays, cost overruns, claims, and disputes.

The following information is provided to help you manage your risks.

Geotechnical Services Are Performed for Specific Purposes, Persons, and Projects

Geotechnical engineers structure their services to meet the specific needs of their clients. A geotechnical engineering study conducted for a civil engineer may not fulfill the needs of a construction contractor or even another civil engineer. Because each geotechnical engineering study is unique, each geotechnical engineering report is unique, prepared *solely* for the client. No one except you should rely on your geotechnical engineering report without first conferring with the geotechnical engineer who prepared it. *And no one — not even you — should apply the report for any purpose or project except the one originally contemplated.*

Read the Full Report

Serious problems have occurred because those relying on a geotechnical engineering report did not read it all. Do not rely on an executive summary. Do not read selected elements only.

A Geotechnical Engineering Report Is Based on A Unique Set of Project-Specific Factors

Geotechnical engineers consider a number of unique, project-specific factors when establishing the scope of a study. Typical factors include: the client's goals, objectives, and risk management preferences; the general nature of the structure involved, its size, and configuration; the location of the structure on the site; and other planned or existing site improvements, such as access roads, parking lots, and underground utilities. Unless the geotechnical engineer who conducted the study specifically indicates otherwise, do not rely on a geotechnical engineering report that was:

- not prepared for you,
- not prepared for your project,
- not prepared for the specific site explored, or
- completed before important project changes were made.

Typical changes that can erode the reliability of an existing geotechnical engineering report include those that affect:

- the function of the proposed structure, as when it's changed from a parking garage to an office building, or from a light industrial plant to a refrigerated warehouse,

- elevation, configuration, location, orientation, or weight of the proposed structure,
- composition of the design team, or
- project ownership.

As a general rule, *always* inform your geotechnical engineer of project changes—even minor ones—and request an assessment of their impact. *Geotechnical engineers cannot accept responsibility or liability for problems that occur because their reports do not consider developments of which they were not informed.*

Subsurface Conditions Can Change

A geotechnical engineering report is based on conditions that existed at the time the study was performed. *Do not rely on a geotechnical engineering report* whose adequacy may have been affected by: the passage of time; by man-made events, such as construction on or adjacent to the site; or by natural events, such as floods, earthquakes, or groundwater fluctuations. *Always* contact the geotechnical engineer before applying the report to determine if it is still reliable. A minor amount of additional testing or analysis could prevent major problems.

Most Geotechnical Findings Are Professional Opinions

Site exploration identifies subsurface conditions only at those points where subsurface tests are conducted or samples are taken. Geotechnical engineers review field and laboratory data and then apply their professional judgment to render an opinion about subsurface conditions throughout the site. Actual subsurface conditions may differ—sometimes significantly—from those indicated in your report. Retaining the geotechnical engineer who developed your report to provide construction observation is the most effective method of managing the risks associated with unanticipated conditions.

A Report's Recommendations Are *Not* Final

Do not overrely on the construction recommendations included in your report. *Those recommendations are not final*, because geotechnical engineers develop them principally from judgment and opinion. Geotechnical engineers can finalize their recommendations only by observing actual

subsurface conditions revealed during construction. *The geotechnical engineer who developed your report cannot assume responsibility or liability for the report's recommendations if that engineer does not perform construction observation.*

A Geotechnical Engineering Report Is Subject to Misinterpretation

Other design team members' misinterpretation of geotechnical engineering reports has resulted in costly problems. Lower that risk by having your geotechnical engineer confer with appropriate members of the design team after submitting the report. Also retain your geotechnical engineer to review pertinent elements of the design team's plans and specifications. Contractors can also misinterpret a geotechnical engineering report. Reduce that risk by having your geotechnical engineer participate in prebid and preconstruction conferences, and by providing construction observation.

Do Not Redraw the Engineer's Logs

Geotechnical engineers prepare final boring and testing logs based upon their interpretation of field logs and laboratory data. To prevent errors or omissions, the logs included in a geotechnical engineering report should *never* be redrawn for inclusion in architectural or other design drawings. Only photographic or electronic reproduction is acceptable, *but recognize that separating logs from the report can elevate risk.*

Give Contractors a Complete Report and Guidance

Some owners and design professionals mistakenly believe they can make contractors liable for unanticipated subsurface conditions by limiting what they provide for bid preparation. To help prevent costly problems, give contractors the complete geotechnical engineering report, *but* preface it with a clearly written letter of transmittal. In that letter, advise contractors that the report was not prepared for purposes of bid development and that the report's accuracy is limited; encourage them to confer with the geotechnical engineer who prepared the report (a modest fee may be required) and/or to conduct additional study to obtain the specific types of information they need or prefer. A prebid conference can also be valuable. *Be sure contractors have sufficient time to perform additional study.* Only then might you be in a position to give contractors the best information available to you, while requiring them to at least share some of the financial responsibilities stemming from unanticipated conditions.

Read Responsibility Provisions Closely

Some clients, design professionals, and contractors do not recognize that geotechnical engineering is far less exact than other engineering disciplines. This lack of understanding has created unrealistic expectations that

have led to disappointments, claims, and disputes. To help reduce the risk of such outcomes, geotechnical engineers commonly include a variety of explanatory provisions in their reports. Sometimes labeled "limitations" many of these provisions indicate where geotechnical engineers' responsibilities begin and end, to help others recognize their own responsibilities and risks. *Read these provisions closely.* Ask questions. Your geotechnical engineer should respond fully and frankly.

Geoenvironmental Concerns Are Not Covered

The equipment, techniques, and personnel used to perform a *geoenvironmental* study differ significantly from those used to perform a *geotechnical* study. For that reason, a geotechnical engineering report does not usually relate any geoenvironmental findings, conclusions, or recommendations; e.g., about the likelihood of encountering underground storage tanks or regulated contaminants. *Unanticipated environmental problems have led to numerous project failures.* If you have not yet obtained your own geoenvironmental information, ask your geotechnical consultant for risk management guidance. *Do not rely on an environmental report prepared for someone else.*

Obtain Professional Assistance To Deal with Mold

Diverse strategies can be applied during building design, construction, operation, and maintenance to prevent significant amounts of mold from growing on indoor surfaces. To be effective, all such strategies should be devised for the *express purpose* of mold prevention, integrated into a comprehensive plan, and executed with diligent oversight by a professional mold prevention consultant. Because just a small amount of water or moisture can lead to the development of severe mold infestations, a number of mold prevention strategies focus on keeping building surfaces dry. While groundwater, water infiltration, and similar issues may have been addressed as part of the geotechnical engineering study whose findings are conveyed in this report, the geotechnical engineer in charge of this project is not a mold prevention consultant; ***none of the services performed in connection with the geotechnical engineer's study were designed or conducted for the purpose of mold prevention. Proper implementation of the recommendations conveyed in this report will not of itself be sufficient to prevent mold from growing in or on the structure involved.***

Rely on Your ASFE-Member Geotechnical Engineer for Additional Assistance

Membership in ASFE/The Best People on Earth exposes geotechnical engineers to a wide array of risk management techniques that can be of genuine benefit for everyone involved with a construction project. Confer with you ASFE-member geotechnical engineer for more information.



8811 Colesville Road/Suite G106, Silver Spring, MD 20910
Telephone: 301/565-2733 Facsimile: 301/589-2017
e-mail: info@asfe.org www.asfe.org

Copyright 2004 by ASFE, Inc. Duplication, reproduction, or copying of this document, in whole or in part, by any means whatsoever, is strictly prohibited, except with ASFE's specific written permission. Excerpting, quoting, or otherwise extracting wording from this document is permitted only with the express written permission of ASFE, and only for purposes of scholarly research or book review. Only members of ASFE may use this document as a complement to or as an element of a geotechnical engineering report. Any other firm, individual, or other entity that so uses this document without being an ASFE member could be committing negligent or intentional (fraudulent) misrepresentation.



November 29, 2018
ES-2964.01

Earth Solutions NW LLC

Geotechnical Engineering, Construction
Observation/Testing and Environmental Services

OB Mercer Island Properties, LLC
5712 East Lake Sammamish Parkway Southeast, Suite 100
Issaquah, Washington 98029

Attention: Mr. Eric Hansen

Dear Mr. Hansen:

Earth Solutions NW, LLC (ESNW) is pleased to present this report titled "Geotechnical Engineering Study, Proposed Residential Development, 3000 West Mercer Way, Mercer Island, Washington". Based on the results of our investigation, construction of the proposed single-family residences and related improvements is feasible from a geotechnical standpoint. Our study indicates the site is underlain primarily by limited areas of fill and glacial till deposits. During our subsurface exploration completed on November 13, 2018, groundwater seepage was not encountered at the test pit locations.

In our opinion, the proposed single-family residences may be supported on conventional continuous and spread footing foundations bearing on competent native soil, recompacted native soil, or new structural fill. We anticipate competent native soil suitable for support of the new foundations will be encountered beginning at depths of approximately two to three feet below existing grades across the majority of the site. Where encountered, loose or unsuitable subgrade areas should be mechanically compacted and/or overexcavated and replaced with structural fill, as recommended by ESNW at the time of construction.

This report provides recommendations for foundation subgrade preparation, foundation and retaining wall design parameters, drainage, and other pertinent geotechnical recommendations. The opportunity to be of service to you is appreciated. If you have any questions regarding the content of this geotechnical engineering study, please call.

Sincerely,

EARTH SOLUTIONS NW, LLC

Adam Z. Shier, G.I.T.
Staff Geologist

Table of Contents

ES-2964.01

	<u>PAGE</u>
<u>INTRODUCTION</u>	1
<u>General</u>	1
<u>Project Description</u>	2
<u>SITE CONDITIONS</u>	2
<u>Surface</u>	2
<u>Subsurface</u>	2
Topsoil and Fill	3
Native Soil	3
Geologic Setting	3
Groundwater	3
<u>Geologically Hazardous Areas Assessment</u>	4
<u>DISCUSSION AND RECOMMENDATIONS</u>	4
<u>General</u>	4
<u>Site Preparation and Earthwork</u>	4
Temporary Erosion Control	4
In-situ and Imported Soils	5
Subgrade Preparation	5
Structural Fill	6
<u>Foundations</u>	6
<u>Seismic Design</u>	6
<u>Slab-on-Grade Floors</u>	7
<u>Retaining Walls</u>	7
<u>Drainage</u>	8
Infiltration Feasibility	8
<u>Excavations and Slopes</u>	9
<u>Utility Support and Trench Backfill</u>	9
<u>Pavement Sections</u>	9
<u>LIMITATIONS</u>	10
<u>Additional Services</u>	10

Table of Contents

Cont'd

ES-2964.01

GRAPHICS

Plate 1	Vicinity Map
Plate 2	Test Pit Location Plan
Plate 3	Retaining Wall Drainage Detail
Plate 4	Footing Drain Detail

APPENDICES

Appendix A	Subsurface Exploration Test Pit Logs
Appendix B	Laboratory Test Results

**GEOTECHNICAL ENGINEERING STUDY
PROPOSED RESIDENTIAL DEVELOPMENT
3000 WEST MERCER WAY
MERCER ISLAND, WASHINGTON**

ES-2964.01

INTRODUCTION

General

This geotechnical engineering study (study) was prepared for the proposed residential development to be constructed at 3000 West Mercer Way, in Mercer Island, Washington. The purpose of this study was to provide geotechnical recommendations for currently proposed development plans. Our scope of services for completing this study included the following:

- Test pits for purposes of characterizing site soil conditions;
- Laboratory testing of soil samples collected at the test pit locations;
- Conducting engineering analyses, and;
- Preparation of this report.

The following documents and maps were reviewed as part of our report preparation:

- Geologic Map of Mercer Island, Washington, by Kathy G. Troost and Aaron P. Wisher, October 2006;
- Mercer Island Seismic Hazard Assessment, Landslide Hazard Assessment, and Erosion Hazard Assessment maps, by Kathy G. Troost and Aaron P. Wisher, April 2009;
- Mercer Island City Code (MICC);
- Stormwater Management Manual for Western Washington, prepared by the Washington State Department of Ecology, amended December 2014;
- Surface Water Design Manual, prepared by the King County Department of Natural Resources and Parks, dated April 24, 2016;
- Low Impact Development Infiltration Feasibility on Mercer Island, Prepared by Herrera;
- Liquefaction Susceptibility Map of King County, Washington, endorsed by the King County Flood Control District, May 2010;
- Conceptual Site Plan, prepared by Blueline, dated July 24, 2018, and;
- Online Web Soil Survey (WSS) resource, provided by the Natural Resources Conservation Service (NRCS) under the United States Department of Agriculture (USDA).

Project Description

Based on the referenced plans, the site will be developed with 14 new single-family residences, an access roadway, and associated infrastructure improvements. Given the local topographic relief across the site, grade cuts and/or fills up to about 10 feet are anticipated to achieve finish grades. Retaining walls and/or rockeries may be incorporated into final designs to accommodate grade transitions, where necessary. Although final plans are still being developed, we anticipate stormwater management will be accomplished through a conventional detention system, as required.

At the time this report was prepared, specific building load values were not available for review. However, we anticipate the proposed residential structures will consist of relatively lightly loaded wood framing supported on conventional foundations. Based on our experience with similar developments, we estimate wall loads of about 1 to 2 kips per linear foot and slab-on-grade loading of about 150 pounds per square foot (psf) will be incorporated into final designs.

If the above design assumptions are incorrect or change, ESNW should be contacted to review the recommendations provided in this report. ESNW should review final designs to verify the geotechnical recommendations provided in this report have been incorporated into the plans.

SITE CONDITIONS

Surface

The subject site is located at 3000 West Mercer Way, immediately southwest of the intersection with Southeast 28th Street, in Mercer Island, Washington. The property is comprised of one tax parcel (King County Parcel No. 217450-2425) totaling roughly 2.87 acres. The property is currently developed with a Boys & Girls Clubs of King County facility, parking areas, and associated improvements.

The site is bordered to the north by Southeast 28th Street, to the east by West Mercer Way, to the south by Southeast 30th Street, and to the west by 62nd Avenue Southeast. Vegetation is comprised primarily of lawn areas, with mature trees along the property boundaries of the site perimeter. Site topography ascends generally from southwest to northeast, and we estimate about 35 feet of elevation change occurs across the site.

Subsurface

As part of the subsurface exploration, six test pits were excavated at accessible locations within the property boundaries on November 13, 2018, using a trackhoe and operator retained by ESNW. The test pits were completed for purposes of assessment and classification of site soils as well as characterization of groundwater conditions within areas proposed for new development. The test pits were advanced to maximum depths of approximately five and-one-half to seven and-one-half feet below the existing ground surface (bgs). Please refer to the test pit logs provided in Appendix A for a more detailed description of the subsurface conditions.

Topsoil and Fill

Topsoil was encountered generally within the upper 3 to 18 inches of existing grades at the test pit locations. The topsoil was characterized by dark brown color, the presence of fine organic material, and small root intrusions. Based on our field observations, we estimate topsoil will be encountered with an average thickness of eight inches across the site.

Fill was encountered at TP-1, TP-2, and TP-4 during our fieldwork. The fill was classified chiefly as silty sand and extended to depths of about two and one-half to three feet bgs. Fill may be present in proximity to the existing structures and utility alignments. If fill is encountered, it may be suitable for re-use as structural fill; however, an ESNW representative should be retained during the construction phase of site development to evaluate the suitability for on-site existing fill soils to be used as structural fill.

Native Soil

Underlying the topsoil and fill, native soils consisted of silty sand and silt (USCS: SM and ML, respectively) at the test pit locations, generally consistent with the typical makeup of glacial till. The in-situ density of the native soil was characterized as medium dense to very dense. Native soils were encountered primarily in a moist condition, extending to the maximum exploration depth of about seven and one-half feet bgs.

Geologic Setting

The referenced geologic map resource identifies glacial till (Qvt) deposits as the primary native soil unit underlying the subject site. Vashon glacial till is chiefly a non-sorted mixture of clay, silt, sand, pebbles, cobbles, and boulders. The till is compact and locally referred to as "hardpan", due to the compaction caused by the great weight of substantially thick, overriding ice. The referenced WSS resource identifies Kitsap silt loam (Map Unit Symbol: KpB) as the primary soil unit underlying the subject site. The Kitsap series was formed in terraces and originates from lacustrine deposits. Based on our field observations, on-site native soils are generally consistent with glacial till (Qvt) deposits.

Groundwater

Groundwater seepage was not encountered during our fieldwork on November 13, 2018. The presence of groundwater seepage should be expected in excavations, especially in a perched condition at the contact between weathered and unweathered glacial till. Where encountered, groundwater will likely be representative of discrete, perched seepage zones rather than a seasonal high groundwater table. Seepage rates and elevations fluctuate depending on many factors, including precipitation duration and intensity, the time of year, and soil conditions. In general, groundwater flow rates are higher during the winter, spring, and early summer months.

Geologically Hazardous Areas Assessment

The MICC was reviewed to evaluate the presence of geologically hazardous areas on site. Based on our investigation and review, geologically hazardous areas are not present on or adjacent to the site.

DISCUSSION AND RECOMMENDATIONS

General

Based on the results of our study, the proposed structures can be supported on conventional continuous and spread footing foundations bearing on competent native soil, recompacted native soil, or new structural fill. We anticipate competent native soil, suitable for support of foundations, will be encountered beginning at depths of about two to three feet below existing grades across the majority of the site. Slab-on-grade floors should be supported on dense native soil, re-compacted native soil, or new structural fill. Organic material exposed at subgrade elevations must be removed, and grades should be restored with structural fill. Where loose, organic, or other unsuitable material is encountered at or below footing subgrade elevations, the incompetent material should be removed and replaced with structural fill, as necessary.

This report has been prepared for the exclusive use of OB Mercer Island Properties, LLC and their representatives. No warranty, expressed or implied, is made. This report has been prepared in a manner consistent with the level of care and skill ordinarily exercised by other members of the profession currently practicing under similar conditions in this area.

Site Preparation and Earthwork

Site preparation activities will consist of installing temporary erosion control measures and performing clearing and site stripping (as necessary). Given the local topographic relief across the site, grade cuts and/or fills up to about 10 feet are anticipated to achieve finish grades. Retaining walls and/or rockeries may be incorporated into final designs to accommodate grade transitions, where necessary.

Temporary Erosion Control

A temporary construction entrance and drive lane, consisting of at least six inches of quarry spalls, should be considered to minimize off-site soil tracking and to provide a stable access entrance surface. Geotextile fabric may also be considered underlying the quarry spalls for greater stability of the temporary construction entrance. Utilization of the existing paved driveway as a means of stable ingress and/or egress may be considered during construction activities. Erosion control measures should consist of silt fencing or similar sediment barriers placed around the site perimeter, especially down-gradient areas. Soil stockpiles should be covered or otherwise protected to reduce soil erosion. Temporary approaches for controlling surface water runoff should be established prior to beginning earthwork activities. Additional Best Management Practices (BMPs), as specified by the project civil engineer and indicated on the plans, should be incorporated into construction activities.

In-situ and Imported Soils

Native soils are moisture sensitive, and successful use of native soils as structural fill will largely be dictated by the moisture content at the time of placement and compaction. If the on-site soils cannot be successfully compacted, the use of an imported soil may be necessary. Soils with fines contents greater than 5 percent typically degrade rapidly when exposed to periods of rainfall.

Imported soil intended for use as structural fill should consist of a well-graded, granular soil with a moisture content that is at or slightly above the optimum level. During wet weather conditions, imported soil intended for use as structural fill should consist of a well-graded, granular soil with a fines content of 5 percent or less (where the fines content is defined as the percent passing the Number 200 sieve, based on the minus three-quarter-inch fraction).

Subgrade Preparation

Following site stripping and removal of existing improvements, cuts and fills will be completed to establish proposed subgrade elevations throughout the site. ESNW should observe the subgrades during initial site preparation activities to confirm soil conditions are as anticipated and to provide supplementary recommendations for subgrade preparation, as necessary. The process of removing existing structures may produce voids where old foundations are removed and where crawl space or basement areas may have been present. Complete restoration of voids from old foundation areas must be executed as part of overall subgrade and building pad preparation activities. The following guidelines for preparing building subgrade areas should be incorporated into the final design:

- Where voids and related demolition disturbances extend below planned subgrade elevations, restoration of these areas should be completed. Structural fill should be used to restore voids or unstable areas resulting from the removal of existing structural elements.
- Recompact, or overexcavate and replace, areas of existing fill or loose native soil exposed at building subgrade elevations. Overexcavations should extend into competent native soils, and structural fill should be utilized to restore subgrade elevations as necessary.
- ESNW should confirm subgrade conditions, as well as the required level of recompaction and/or overexcavation and replacement, during site preparation activities. ESNW should also evaluate the overall suitability of prepared subgrade areas following site preparation activities.

Supplementary recommendations for subgrade improvement may be provided at the time of construction and would likely include further mechanical compaction and/or overexcavation and replacement with suitable structural fill.

Structural Fill

Structural fill is defined as compacted soil placed in foundation, slab-on-grade, roadway, permanent slope, retaining wall, and utility trench areas. Soils placed in structural areas should be placed in loose lifts of 12 inches or less and compacted to a relative compaction of 95 percent, based on the laboratory maximum dry density as determined by the Modified Proctor Method (ASTM D1557). For soil placed in utility trenches underlying structural areas, compaction requirements are dictated by the local city, county, or utility district and are typically specified to a relative compaction of at least 95 percent.

Foundations

In our opinion, the proposed residential structures may be supported on conventional continuous and spread footing foundations bearing on competent native soil, recompacted native soil, or new structural fill. We anticipate competent native soil suitable for support of the new foundations will be encountered beginning at depths of about two to three feet bgs across the majority of the site. Loose or unsuitable subgrade areas should be mechanically compacted and/or overexcavated and replaced with structural fill, as recommended by ESNW at the time of construction. Provided foundations will be supported as prescribed, the following parameters may be used for design:

- Allowable soil bearing capacity 2,500 psf
- Passive earth pressure 300 pcf (equivalent fluid)
- Coefficient of friction 0.40

A one-third increase in the allowable soil bearing capacity may be assumed for short-term wind and seismic loading conditions. The above passive pressure and friction values include a factor-of-safety of 1.5. With structural loading as expected, total settlement in the range of one inch and differential settlement of approximately one-half inch is anticipated. The majority of anticipated settlement should occur during construction, as dead loads are applied.

Seismic Design

The 2015 International Building Code recognizes the American Society of Civil Engineers (ASCE) for seismic site class definitions. In accordance with Table 20.3-1 of the ASCE Minimum Design Loads for Buildings and Other Structures manual, Site Class D should be used for design.

The referenced liquefaction susceptibility map indicates the site and surrounding areas maintain very low to low liquefaction susceptibility. Liquefaction is a phenomenon where saturated and loose soils suddenly lose internal strength and behave as a fluid. This behavior is in response to increased pore water pressures resulting from an earthquake or other intense ground shaking. In our opinion, site susceptibility to liquefaction may be characterized as low. The relative density and cohesive nature of the native soils as well as the absence of an established, near-surface groundwater table were the primary bases for this characterization.

Slab-on-Grade Floors

Slab-on-grade floors for the proposed residential structures should be supported on well-compacted, firm and unyielding subgrades. Where feasible, native soils exposed at the slab-on-grade subgrade levels can likely be compacted in situ to the specifications of structural fill. Unstable or yielding subgrade areas should be recompacted, or overexcavated and replaced with suitable structural fill, prior to slab construction.

A capillary break consisting of a minimum of four inches of free-draining crushed rock or gravel should be placed below slab. The free-draining material should have a fines content of 5 percent or less (where the fines content is defined as the percent passing the Number 200 sieve, based on the minus three-quarter inch fraction). In areas where slab moisture is undesirable, installation of a vapor barrier below each slab should be considered. If a vapor barrier is to be utilized, it should be a material specifically designed for use as a vapor barrier and should be installed in accordance with the specifications of the manufacturer.

Retaining Walls

Retaining walls must be designed to resist earth pressures and applicable surcharge loads. The following parameters may be used for retaining wall design:

- Active earth pressure (unrestrained condition) 35 pcf
- At-rest earth pressure (restrained condition) 55 pcf
- Traffic surcharge* (passenger vehicles) 70 psf (rectangular distribution)
- Passive earth pressure 300 pcf
- Coefficient of friction 0.40
- Seismic surcharge 6H psf**

* Where applicable

** Where H equals the retained height (in feet)

Additional surcharge loading from adjacent foundations, sloped backfill, retaining walls, or other loads should be included in the retaining wall design. Drainage should be provided behind retaining walls such that hydrostatic pressures do not develop. If drainage is not provided, hydrostatic pressures should be included in the wall design.

Retaining walls should be backfilled with at least 18 inches of free-draining material or suitable sheet drainage that extends along the height of the wall. The upper one foot of the wall backfill may consist of a less permeable soil, if desired. A perforated drain pipe should be placed along the base of the wall and connected to an approved discharge location. A typical retaining wall drainage detail is provided on Plate 3.

Drainage

Shallow groundwater seepage was not encountered at the time of our subsurface exploration. However, localized zones of seepage should be expected in excavations. Where localized zones of groundwater seepage are encountered, temporary measures to control groundwater seepage may be needed. Temporary measures to control groundwater seepage and surface water runoff during construction will likely involve passive elements such as interceptor trenches and sumps, as necessary.

Surface grades must be designed to direct water away from slopes and buildings. The grade adjacent to buildings should be sloped away from the buildings at a gradient of at least 2 percent for a horizontal distance of four feet (minimum) and ten feet (maximum) as building and property setbacks allow. In our opinion, perimeter footing drains should be installed at or below the invert of the building footings. A typical footing drain detail is provided on Plate 4 of this report.

Infiltration Feasibility

This infiltration feasibility evaluation is primarily based on our field observations, laboratory testing of representative soils samples, and local geologic mapping.

Site soils consist of medium dense to very dense glacial till deposits beginning at relatively shallow depths in relation to existing site gradients. These soils can further be classified as loam, according to USDA textural analysis. Irrespective of gravel content, fines contents within the native till were roughly 42 to 96 percent at the tested locations. Based on our experience with similar deposits, these soils typically exhibit negligible infiltration capacity. From a geotechnical standpoint, native soils are characteristic of hydraulically restrictive soil layers and should be considered impervious for practicable design purposes. Additionally, review of the referenced low Impact Development Infiltration Feasibility on Mercer Island Map indicates the site is within an area where infiltrating LID facilities are not permitted.

Considering the above, it is our opinion the site is not feasible for infiltrating LID facilities or similar BMPS. We recommend alternative means of stormwater management be considered for this project.

Excavations and Slopes

The Federal Occupation Safety and Health Administration (OSHA) and the Washington Industrial Safety and Health Act (WISHA) provide soil classification in terms of temporary slope inclinations. Based on the soil conditions encountered at the test pit locations, the weathered glacial till encountered in the upper approximately four to five feet of the test pit locations and where fill and/or groundwater seepage is exposed are classified as Type C by OSHA and WISHA. Temporary slopes over four feet in height in Type C soils must be sloped no steeper than 1.5H:1V (Horizontal:Vertical). Dense to very dense, unweathered, native glacial till where groundwater seepage is not exposed would be classified as Type A by OSHA and WISHA. Temporary slopes over four feet in height in Type A soils must be sloped no steeper than 0.75H:1V. The presence of perched groundwater may cause caving of the temporary slopes. ESNW should observe site excavations to confirm soil types and allowable slope inclinations are appropriate for the soil exposed by the excavation; steeper temporary slope inclinations may be feasible and should be evaluated by ESNW during construction. If the recommended temporary slope inclination cannot be achieved, temporary shoring may be necessary to support excavations.

Permanent slopes should maintain a gradient of 2H:1V, or flatter, and should be planted with vegetation to enhance stability and to minimize erosion. A representative of ESNW should observe temporary and permanent slopes to confirm the slope inclinations are suitable for the exposed soil conditions and to provide additional excavation and slope recommendations, as necessary.

Utility Support and Trench Backfill

In our opinion, the soils observed at the test pit locations are generally suitable for support of utilities. The native soils are moisture sensitive, and successful use of native soils as structural backfill in utility trench excavations will largely depend on in-situ moisture contents at the time of placement and compaction. Moisture conditioning or cement treatment of the soils may be necessary at some locations prior to use as structural fill. If utility backfill occurs during wet weather, either cement treatment (where allowed by the presiding jurisdiction) of native soils or import of suitable structural fill will be necessary. Utility trench backfill should be placed and compacted to either the specifications of structural fill provided in this report or to the applicable requirements of the presiding jurisdiction.

Pavement Sections

The performance of site pavements is largely related to the condition of the underlying subgrade. To ensure adequate pavement performance, the subgrade should be in a firm and unyielding condition when subjected to proofrolling with a loaded dump truck. Structural fill in pavement areas should be compacted to the specifications detailed in the *Site Preparation and Earthwork* section of this report. Soft, wet, or otherwise unsuitable subgrade areas may still exist after base grading activities. Areas of unsuitable or yielding subgrade conditions may require remedial measures, such as overexcavation and replacement with structural fill or thicker crushed rock sections, prior to pavement.

For relatively lightly loaded pavements subjected to automobiles and occasional truck traffic, the following sections may be considered for preliminary design:

- Two inches of hot-mix asphalt (HMA) placed over four inches of crushed rock base (CRB), or;
- Two inches of HMA placed over three inches of asphalt-treated base (ATB).

Main access drives and frontage improvement areas may require thicker pavement sections. The HMA, CRB and ATB materials should conform to WSDOT specifications. The City of Mercer Island or King County minimum pavement requirements may supersede the recommendations provided in this report.

LIMITATIONS

The recommendations and conclusions provided in this study are professional opinions consistent with the level of care and skill that is typical of other members in the profession currently practicing under similar conditions in this area. A warranty is neither expressed nor implied. Variations in the soil and groundwater conditions observed at the test pit locations may exist and may not become evident until construction. ESNW should reevaluate the conclusions provided in this study if variations are encountered.

Additional Services

ESNW should have an opportunity to review final project plans with respect to the geotechnical recommendations provided in this study. ESNW should also be retained to provide observation, testing and consultation services during planning, development, and construction activities.

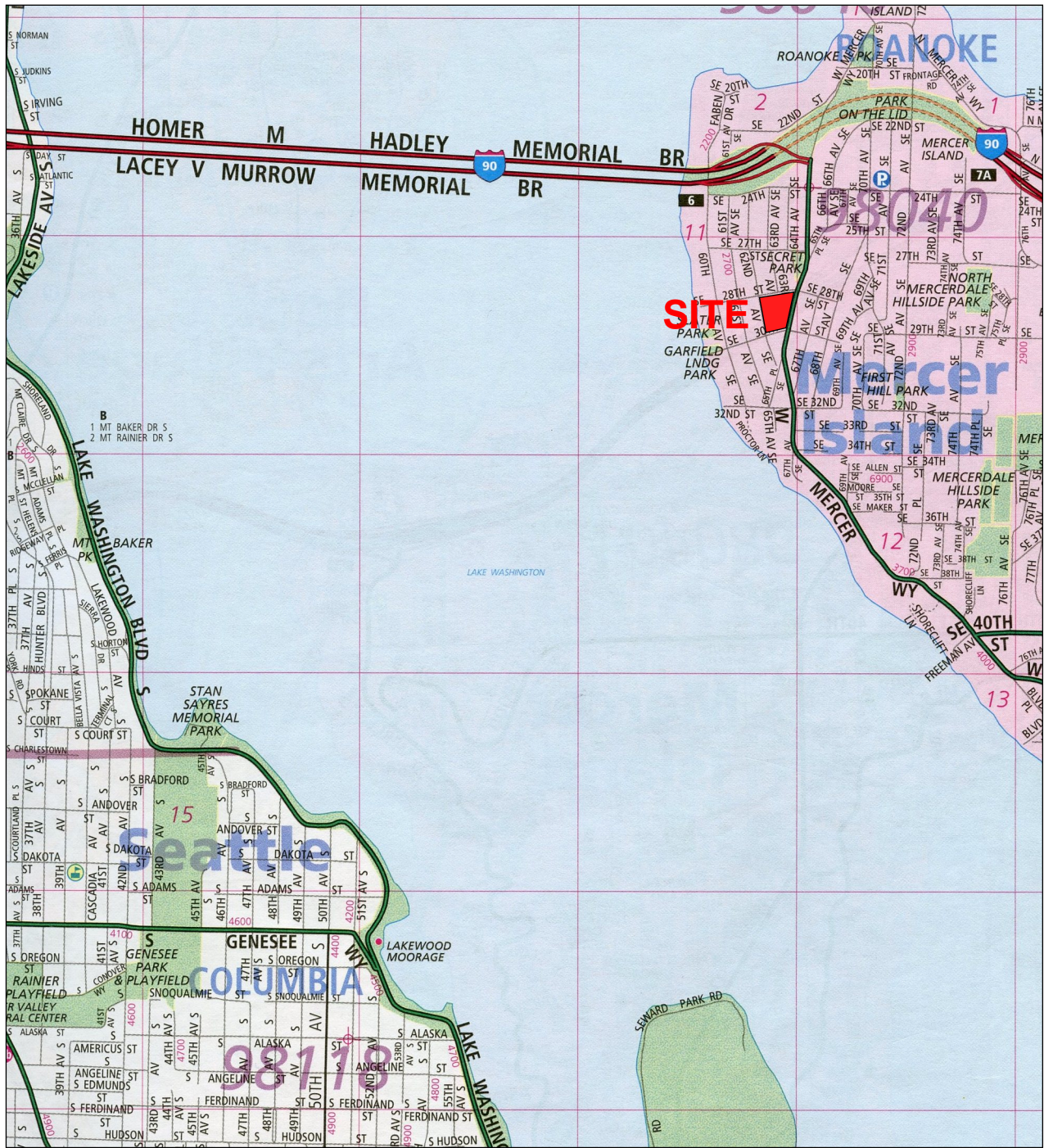

Reference:
 King County, Washington
 Map 595
 By The Thomas Guide
 Rand McNally
 32nd Edition



NOTE: This plate may contain areas of color. ESNW cannot be responsible for any subsequent misinterpretation of the information resulting from black & white reproductions of this plate.



Earth
Solutions
NW LLC

Earth Solutions NW LLC



Geotechnical Engineering, Construction
Observation/Testing and Environmental Services

Vicinity Map
 3000 W. Mercer
 Mercer Island, Washington

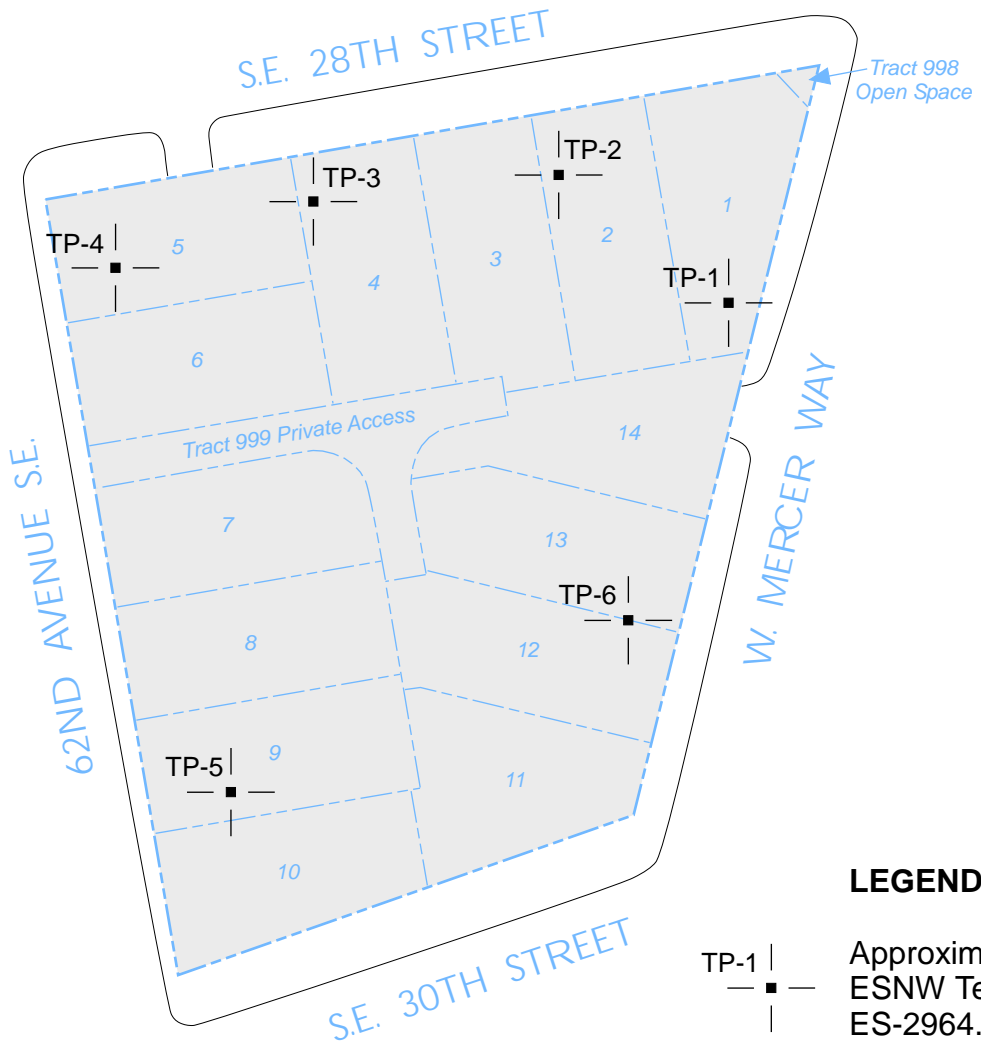
Drwn. CAM	Date 11/21/2018	Proj. No. 2964.01
Checked AZS	Date Nov. 2018	Plate 1

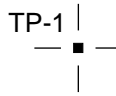

LEGEND

- 
 Approximate Location of ESNW Test Pit, Proj. No. ES-2964.01, Nov. 2018
- 
 Subject Site
- 
 Proposed Lot Number

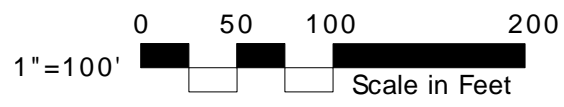

NOTE: The graphics shown on this plate are not intended for design purposes or precise scale measurements, but only to illustrate the approximate test locations relative to the approximate locations of existing and / or proposed site features. The information illustrated is largely based on data provided by the client at the time of our study. ESNW cannot be responsible for subsequent design changes or interpretation of the data by others.

NOTE: This plate may contain areas of color. ESNW cannot be responsible for any subsequent misinterpretation of the information resulting from black & white reproductions of this plate.



Earth Solutions NW_{LLC}

Geotechnical Engineering, Construction
Observation/Testing and Environmental Services

Test Pit Location Plan
3000 W. Mercer
Mercer Island, Washington

Drwn. CAM	Date 11/21/2018	Proj. No. 2964.01
Checked AZS	Date Nov. 2018	Plate 2

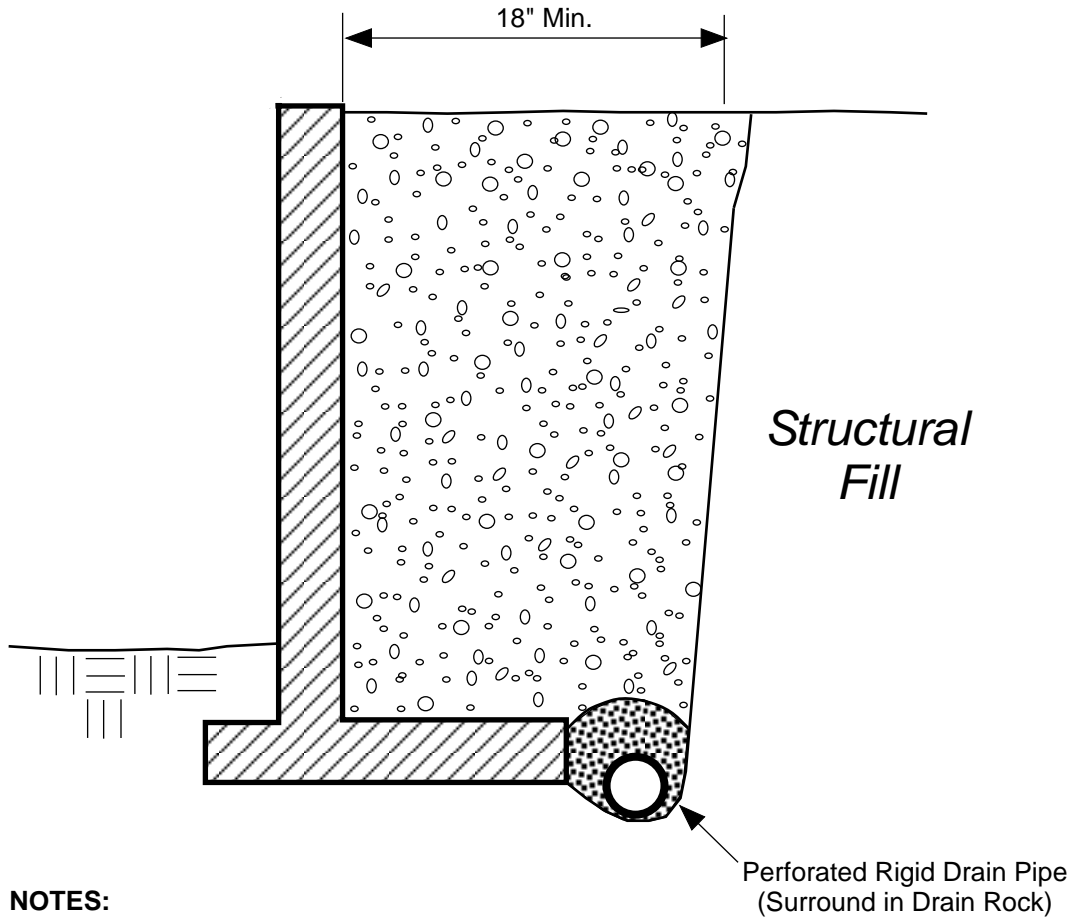

NOTES:

- Free-draining Backfill should consist of soil having less than 5 percent fines. Percent passing No. 4 sieve should be 25 to 75 percent.
- Sheet Drain may be feasible in lieu of Free-draining Backfill, per ESNW recommendations.
- Drain Pipe should consist of perforated, rigid PVC Pipe surrounded with 1-inch Drain Rock.

SCHMATIC ONLY - NOT TO SCALE
NOT A CONSTRUCTION DRAWING

LEGEND:

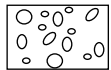

Free-draining Structural Backfill

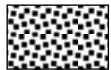

1-inch Drain Rock

		Earth Solutions NW_{LLC} Geotechnical Engineering, Construction Observation/Testing and Environmental Services	
Retaining Wall Drainage Detail 3000 W. Mercer Mercer Island, Washington			
Drwn. CAM	Date 11/21/2018	Proj. No.	2964.01
Checked AZS	Date Nov. 2018	Plate	3

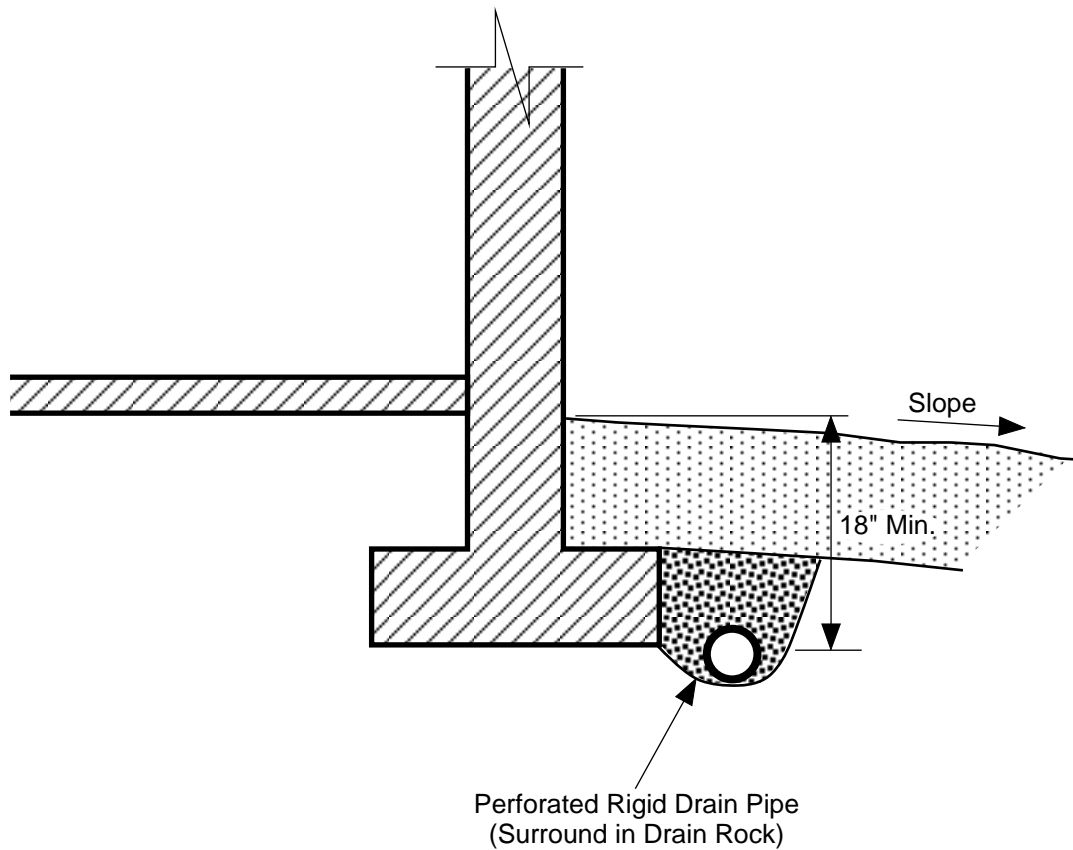

NOTES:

- Do NOT tie roof downspouts to Footing Drain.
- Surface Seal to consist of 12" of less permeable, suitable soil. Slope away from building.

SCHEMATIC ONLY - NOT TO SCALE
NOT A CONSTRUCTION DRAWING

LEGEND:

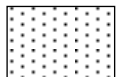

Surface Seal: native soil or other low-permeability material.



1-inch Drain Rock

	Earth Solutions NW_{LLC} Geotechnical Engineering, Construction Observation/Testing and Environmental Services	
	Footing Drain Detail 3000 W. Mercer Mercer Island, Washington	
Drwn. CAM	Date 11/21/2018	Proj. No. 2964.01
Checked AZS	Date Nov. 2018	Plate 4

Appendix A

Subsurface Exploration Test Pit Logs

ES-2964.01

The subsurface conditions at the site were explored by excavating six test pits at the approximate locations illustrated on Plate 2 of this report. The test pit logs are provided in this Appendix. The subsurface exploration was completed on November 13, 2018. The test pits were excavated to a maximum depth of about seven and-one-half feet bgs.

The final logs represent the interpretations of the field logs and the results of laboratory analyses. The stratification lines on the logs represent the approximate boundaries between soil types. In actuality, the transitions may be more gradual.

Earth Solutions NW_{LLC}

SOIL CLASSIFICATION CHART

MAJOR DIVISIONS			SYMBOLS		TYPICAL DESCRIPTIONS	
			GRAPH	LETTER		
COARSE GRAINED SOILS MORE THAN 50% OF MATERIAL IS LARGER THAN NO. 200 SIEVE SIZE	GRAVEL AND GRAVELLY SOILS MORE THAN 50% OF COARSE FRACTION RETAINED ON NO. 4 SIEVE	CLEAN GRAVELS (LITTLE OR NO FINES)		GW	WELL-GRADED GRAVELS, GRAVEL - SAND MIXTURES, LITTLE OR NO FINES	
		GRAVELS WITH FINES (APPRECIABLE AMOUNT OF FINES)		GP	POORLY-GRADED GRAVELS, GRAVEL - SAND MIXTURES, LITTLE OR NO FINES	
		GRAVELS WITH FINES (APPRECIABLE AMOUNT OF FINES)		GM	SILTY GRAVELS, GRAVEL - SAND - SILT MIXTURES	
		GRAVELS WITH FINES (APPRECIABLE AMOUNT OF FINES)		GC	CLAYEY GRAVELS, GRAVEL - SAND - CLAY MIXTURES	
	SAND AND SANDY SOILS MORE THAN 50% OF COARSE FRACTION PASSING ON NO. 4 SIEVE	CLEAN SANDS (LITTLE OR NO FINES)		SW	WELL-GRADED SANDS, GRAVELLY SANDS, LITTLE OR NO FINES	
		CLEAN SANDS (LITTLE OR NO FINES)		SP	POORLY-GRADED SANDS, GRAVELLY SAND, LITTLE OR NO FINES	
		SANDS WITH FINES (APPRECIABLE AMOUNT OF FINES)		SM	SILTY SANDS, SAND - SILT MIXTURES	
		SANDS WITH FINES (APPRECIABLE AMOUNT OF FINES)		SC	CLAYEY SANDS, SAND - CLAY MIXTURES	
		SILTS AND CLAYS LIQUID LIMIT LESS THAN 50	SILTS AND CLAYS LIQUID LIMIT LESS THAN 50		ML	INORGANIC SILTS AND VERY FINE SANDS, ROCK FLOUR, SILTY OR CLAYEY FINE SANDS OR CLAYEY SILTS WITH SLIGHT PLASTICITY
			SILTS AND CLAYS LIQUID LIMIT LESS THAN 50		CL	INORGANIC CLAYS OF LOW TO MEDIUM PLASTICITY, GRAVELLY CLAYS, SANDY CLAYS, SILTY CLAYS, LEAN CLAYS
SILTS AND CLAYS LIQUID LIMIT LESS THAN 50			OL	ORGANIC SILTS AND ORGANIC SILTY CLAYS OF LOW PLASTICITY		
SILTS AND CLAYS LIQUID LIMIT GREATER THAN 50	SILTS AND CLAYS LIQUID LIMIT GREATER THAN 50		MH	INORGANIC SILTS, MICACEOUS OR DIATOMACEOUS FINE SAND OR SILTY SOILS		
	SILTS AND CLAYS LIQUID LIMIT GREATER THAN 50		CH	INORGANIC CLAYS OF HIGH PLASTICITY		
	SILTS AND CLAYS LIQUID LIMIT GREATER THAN 50		OH	ORGANIC CLAYS OF MEDIUM TO HIGH PLASTICITY, ORGANIC SILTS		
HIGHLY ORGANIC SOILS				PT	PEAT, HUMUS, SWAMP SOILS WITH HIGH ORGANIC CONTENTS	

DUAL SYMBOLS are used to indicate borderline soil classifications.

The discussion in the text of this report is necessary for a proper understanding of the nature of the material presented in the attached logs.



Earth Solutions NW
 1805 - 136th Place N.E., Suite 201
 Bellevue, Washington 98005
 Telephone: 425-449-4704
 Fax: 425-449-4711



PROJECT NUMBER ES-2964.01 PROJECT NAME 3000 W. Mercer
 DATE STARTED 11/13/18 COMPLETED 11/13/18 GROUND ELEVATION _____ TEST PIT SIZE _____
 EXCAVATION CONTRACTOR NW Excavating GROUND WATER LEVELS:
 EXCAVATION METHOD _____ AT TIME OF EXCAVATION ---
 LOGGED BY AZS CHECKED BY HTW AT END OF EXCAVATION ---
 NOTES Depth of Topsoil & Sod 6": grass AFTER EXCAVATION ---

DEPTH (ft)	SAMPLE TYPE NUMBER	TESTS	U.S.C.S.	GRAPHIC LOG	MATERIAL DESCRIPTION
0					
			TPSL	0.5	Dark brown TOPSOIL (Fill)
		MC = 19.60%	SM		Gray silty SAND with gravel, medium dense, wet (Fill) -abundant cobbles
		MC = 18.90%		3.0	
5			SM		Gray silty SAND, medium dense to dense, wet -weakly cemented, iron oxide staining
		MC = 12.40%		7.5	
					Test pit terminated at 7.5 feet below existing grade. No groundwater encountered during excavation. No caving observed. Bottom of test pit at 7.5 feet.



Earth Solutions NW
 1805 - 136th Place N.E., Suite 201
 Bellevue, Washington 98005
 Telephone: 425-449-4704
 Fax: 425-449-4711

PROJECT NUMBER ES-2964.01 PROJECT NAME 3000 W. Mercer
 DATE STARTED 11/13/18 COMPLETED 11/13/18 GROUND ELEVATION _____ TEST PIT SIZE _____
 EXCAVATION CONTRACTOR NW Excavating GROUND WATER LEVELS:
 EXCAVATION METHOD _____ AT TIME OF EXCAVATION ---
 LOGGED BY AZS CHECKED BY HTW AT END OF EXCAVATION ---
 NOTES Depth of Topsoil & Sod 3": grass AFTER EXCAVATION ---

DEPTH (ft)	SAMPLE TYPE NUMBER	TESTS	U.S.C.S.	GRAPHIC LOG	MATERIAL DESCRIPTION
0					
		MC = 12.50%	TPSL		0.3 Dark brown TOPSOIL (Fill) Brown silty SAND, medium dense, moist (Fill)
		MC = 7.80% Fines = 29.80%	SM		2.5 Gray silty SAND with gravel, dense, moist [USDA Classification: gravelly fine sandy LOAM] -weakly cemented
5			SM		
		MC = 13.30%			7.0 Test pit terminated at 7.0 feet below existing grade. No groundwater encountered during excavation. No caving observed. Bottom of test pit at 7.0 feet.





Earth Solutions NW
 1805 - 136th Place N.E., Suite 201
 Bellevue, Washington 98005
 Telephone: 425-449-4704
 Fax: 425-449-4711

TEST PIT NUMBER TP-3

PAGE 1 OF 1

PROJECT NUMBER ES-2964.01 PROJECT NAME 3000 W. Mercer
 DATE STARTED 11/13/18 COMPLETED 11/13/18 GROUND ELEVATION _____ TEST PIT SIZE _____
 EXCAVATION CONTRACTOR NW Excavating GROUND WATER LEVELS:
 EXCAVATION METHOD _____ AT TIME OF EXCAVATION ---
 LOGGED BY AZS CHECKED BY HTW AT END OF EXCAVATION ---
 NOTES Depth of Topsoil & Sod 6": grass AFTER EXCAVATION ---

DEPTH (ft)	SAMPLE TYPE NUMBER	TESTS	U.S.C.S.	GRAPHIC LOG	MATERIAL DESCRIPTION	
0						
		MC = 10.30%	TPSL		0.5	Dark brown TOPSOIL
			SM		1.5	Brown silty SAND, medium dense, damp
		MC = 11.80%	SM			Gray silty SAND, dense, moist -weakly cemented
5					6.5	Test pit terminated at 6.5 feet below existing grade. No groundwater encountered during excavation. No caving observed. Bottom of test pit at 6.5 feet.



Earth Solutions NW
 1805 - 136th Place N.E., Suite 201
 Bellevue, Washington 98005
 Telephone: 425-449-4704
 Fax: 425-449-4711

TEST PIT NUMBER TP-4

PROJECT NUMBER ES-2964.01 PROJECT NAME 3000 W. Mercer
 DATE STARTED 11/13/18 COMPLETED 11/13/18 GROUND ELEVATION _____ TEST PIT SIZE _____
 EXCAVATION CONTRACTOR NW Excavating GROUND WATER LEVELS:
 EXCAVATION METHOD _____ AT TIME OF EXCAVATION ---
 LOGGED BY AZS CHECKED BY HTW AT END OF EXCAVATION ---
 NOTES Depth of Topsoil & Sod 4": grass AFTER EXCAVATION ---

DEPTH (ft)	SAMPLE TYPE NUMBER	TESTS	U.S.C.S.	GRAPHIC LOG	MATERIAL DESCRIPTION
0			TPSL		0.4 Dark brown TOPSOIL (Fill)
			SM		Brownish gray silty SAND with gravel, medium dense, moist (Fill)
		MC = 16.70%			2.5 Gray silty SAND, dense, moist
5		MC = 16.00%	SM		
					6.5 Gray SILT, dense, wet
		MC = 42.00% Fines = 96.00%	ML		7.5 [USDA Classification: LOAM]
					Test pit terminated at 7.5 feet below existing grade. No groundwater encountered during excavation. No caving observed. Bottom of test pit at 7.5 feet.



Earth Solutions NW
 1805 - 136th Place N.E., Suite 201
 Bellevue, Washington 98005
 Telephone: 425-449-4704
 Fax: 425-449-4711

TEST PIT NUMBER TP-5

PROJECT NUMBER ES-2964.01 PROJECT NAME 3000 W. Mercer
 DATE STARTED 11/13/18 COMPLETED 11/13/18 GROUND ELEVATION _____ TEST PIT SIZE _____
 EXCAVATION CONTRACTOR NW Excavating GROUND WATER LEVELS:
 EXCAVATION METHOD _____ AT TIME OF EXCAVATION ---
 LOGGED BY AZS CHECKED BY HTW AT END OF EXCAVATION ---
 NOTES Depth of Topsoil & Sod 18": grass AFTER EXCAVATION ---

DEPTH (ft)	SAMPLE TYPE NUMBER	TESTS	U.S.C.S.	GRAPHIC LOG	MATERIAL DESCRIPTION	
0					Dark brown TOPSOIL	
		MC = 11.00%	TPSL			
			SM		1.5	Brown silty SAND, medium dense, moist
			SM		3.5	Gray silty SAND, dense, moist
5					5.5	Test pit terminated at 5.5 feet below existing grade. No groundwater encountered during excavation. No caving observed. Bottom of test pit at 5.5 feet.



Earth Solutions NW
 1805 - 136th Place N.E., Suite 201
 Bellevue, Washington 98005
 Telephone: 425-449-4704
 Fax: 425-449-4711

TEST PIT NUMBER TP-6

PAGE 1 OF 1

PROJECT NUMBER ES-2964.01 PROJECT NAME 3000 W. Mercer
 DATE STARTED 11/13/18 COMPLETED 11/13/18 GROUND ELEVATION _____ TEST PIT SIZE _____
 EXCAVATION CONTRACTOR NW Excavating GROUND WATER LEVELS:
 EXCAVATION METHOD _____ AT TIME OF EXCAVATION ---
 LOGGED BY AZS CHECKED BY HTW AT END OF EXCAVATION ---
 NOTES Depth of Topsoil & Sod 4": grass AFTER EXCAVATION ---

DEPTH (ft)	SAMPLE TYPE NUMBER	TESTS	U.S.C.S.	GRAPHIC LOG	MATERIAL DESCRIPTION
0					
		MC = 9.10% Fines = 68.40%	TPSL		0.4 Dark brown TOPSOIL
			SM		1.5 Brown silty SAND, medium dense, damp
5			ML		6.0 Gray sandy SILT, dense, moist [USDA Classification: slightly gravelly LOAM] -weakly cemented
		MC = 10.70%			Test pit terminated at 6.0 feet below existing grade due to refusal on very dense till. No groundwater encountered during excavation. No caving observed. Bottom of test pit at 6.0 feet.

Appendix B
Laboratory Test Results
ES-2964.01



Earth Solutions NW, LLC
 1805 - 136th PL N.E., Suite 201
 Bellevue, WA 98005
 Telephone: 425-449-4704
 Fax: 425-449-4711

GRAIN SIZE DISTRIBUTION

PROJECT NUMBER ES-2964.01

PROJECT NAME 3000 West Mercer

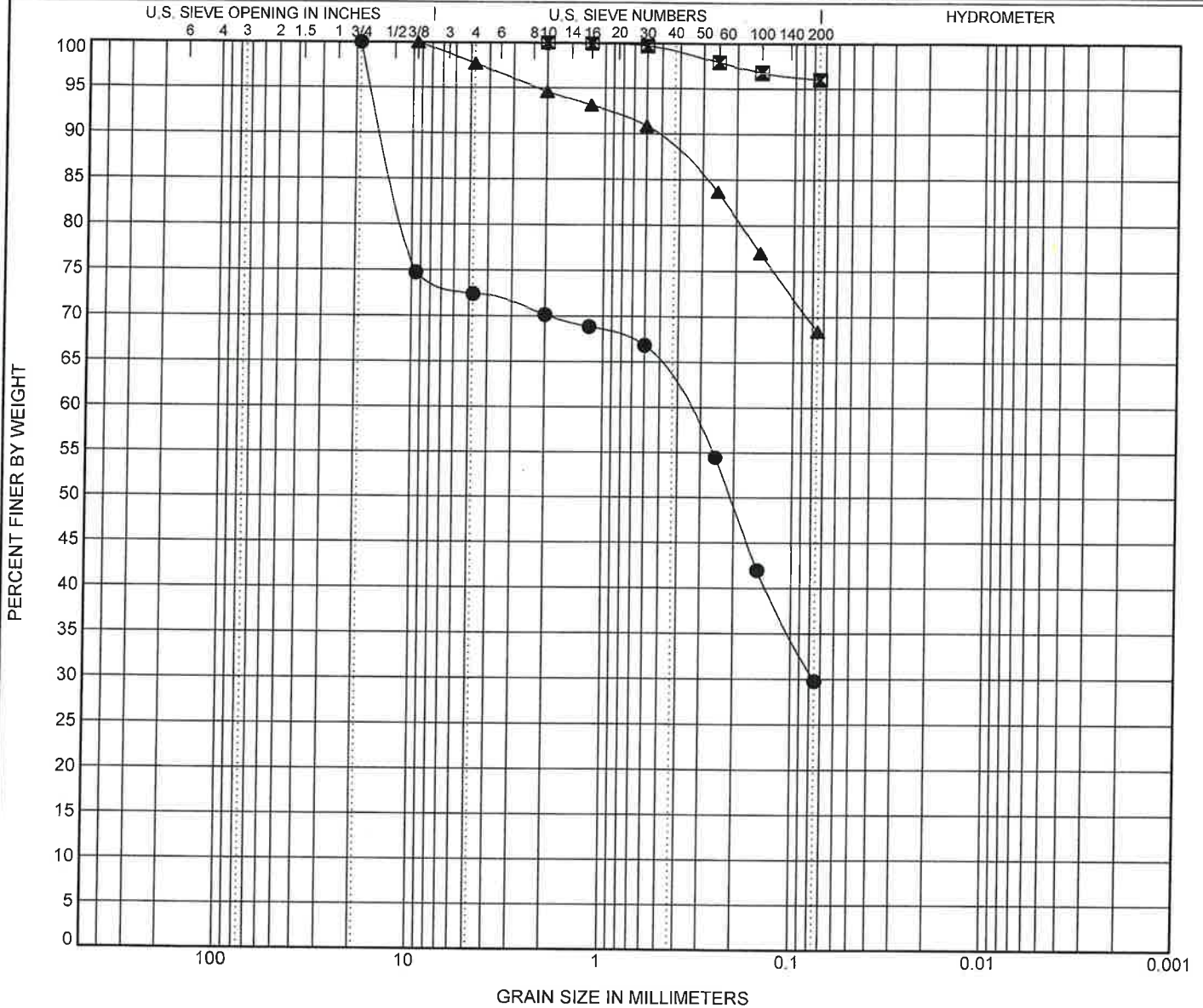

Report Distribution

ES-2964.01

EMAIL ONLY

**OB Mercer Island Properties, LLC
5712 East Lake Sammamish Parkway Southeast, Suite 100
Issaquah, Washington 98029**

Attention: Mr. Eric Hansen

EMAIL ONLY

**Blueline
25 Central Way, Suite 400
Kirkland, Washington 98033**

Attention: Mr. Todd Oberg

January 18, 2019

Eric Hansen
Hansen Real Estate, LLC
5712 E. Lk Sammamish Pkwy SE, #100
Issaquah, WA 98029
Via email: eric@hansencre.com

Re: Critical Area Reconnaissance Memorandum

The Watershed Company Reference Number: 181230

Dear Eric:

We are pleased to present you with the findings of our critical area reconnaissance on the property located at 2825 W Mercer Way in the City of Mercer Island (parcel #2174502425). On January 15, 2019 Ecologist Roen Hohlfeld visited the property to screen for jurisdictional wetlands, watercourses, or any identifiable wildlife habitat conservation areas within or adjacent to property boundaries.

As shown on the attached sketch, there are two non-jurisdictional ditches on or near the subject parcel. One ditch is located along W Mercer Way near the eastern parcel boundary, and the second ditch is along 62nd Avenue SE at the west parcel line. No wetlands or streams were identified on the parcel and no identifiable wildlife habitat conservation areas were observed at the time of the site visit.

Climatic conditions were considered normal on the day of the site visit. The subject parcel is a 2.87-acre property located within the City of Mercer Island, and zoned R-8.4. The parcel slopes slightly to the west. A vacant building is located in the south/central portion of the parcel, with two parking lots on either side. These impervious surfaces cover approximately 2/3 of the parcel.

The remaining third of the parcel is landscaped with a maintained lawn and ornamental shrubs and trees. Lawn areas included common weeds such as Queen Anne's lace, hairy cat's ear, dandelion, plantain, and dock. Common trees on the subject parcel included pine, plum,

Leyland cypress, and madrone. This community of plants is not generally indicative of wetland conditions, and soil and hydrology wetland indicators were not present.

U.S. Fish and Wildlife Service National Wetland Inventory (NWI) maps do not depict any wetlands or streams on the subject parcel. NWI depicts Lake Washington approximately 825 feet west of the subject parcel. No wetlands, streams, or wildlife networks are identified within this area.

Please note: The information contained in this memo is based on the application of technical guidelines currently accepted as the best available science. All discussions, conclusions and recommendations reflect the best professional judgment of the author(s) and are based upon information available to us at the time the study was conducted. All work was completed in good faith, within the constraints of budget, scope, and timing. The findings of this report are subject to verification and agreement by the appropriate local, State and Federal regulatory authorities. No warranty, expressed or implied, is made.

Should you have any questions or concerns regarding our findings, please feel free to contact me.

Sincerely,

A handwritten signature in black ink, appearing to read 'RH', is positioned below the text 'Sincerely,'.

Roen Hohlfeld, Ecologist

Section 7 Other Permits

No other permits are required at this time.



Section 8 Operations and Maintenance

Operations and maintenance guidelines will be included with the final engineering submittal.



Section 9 Bond Quantities

A bond quantity worksheet will be provided with the final engineering submittal, if required.

